



analog RYTM

USER MANUAL

FCC compliance statement

This device complies with part 15 of the FCC rules. Operation is subject to the following two conditions: (1) This device may not cause harmful interference, and (2) this device must accept any interference received, including interference that may cause undesired operation.

NOTE: This equipment has been tested and found to comply with the limits for a Class B digital device, pursuant to Part 15 of the FCC Rules. These limits are designed to provide reasonable protection against harmful interference in a residential installation. This equipment generates, uses and can radiate radio frequency energy and, if not installed and used in accordance with the instructions, may cause harmful interference to radio communications. However, there is no guarantee that interference will not occur in a particular installation. If this equipment does cause harmful interference to radio or television reception, which can be determined by turning the equipment off and on, the user is encouraged to try to correct the interference by one or more of the following measures:

- Reorient or relocate the receiving antenna.
- Increase the separation between the equipment and receiver.
- Connect the equipment into an outlet on a circuit different from that to which the receiver is connected.
- Consult the dealer or an experienced radio/TV technician for help.

 **WARNING:** Cancer and Reproductive Harm – www.P65Warnings.ca.gov

Canada

This This Class B digital apparatus complies with Canadian ICES-003.
Cet appareil numérique de la classe B est conforme à la norme NMB-003

European Union regulation compliance statement

This product has been tested to comply with the Low Voltage Directive 2006/95/EC and the Electromagnetic Compatibility Directive 2004/108/EC. The product meets the requirements of RoHS 2 Directive 2011/65/EU.



This symbol indicates that your product must be disposed of properly according to local laws and regulations.

Legal disclaimer

The information in this document is subject to change without notice and should not be construed as a commitment by Elektron. Elektron assumes no responsibility for any errors that may appear in this document. Elektron may also make improvements and/or changes in the products and programs described in this document at any time without notice. In no event shall Elektron be liable for any special, indirect, or consequential damages or any damages whatsoever resulting from loss of use, data, or profits, whether in an action of contract, negligence, or other action, arising out of or in connection with the use or performance of this information.

IMPORTANT SAFETY AND MAINTENANCE INSTRUCTIONS

Please read these instructions carefully and adhere to the operating advice.

1. Do not use this unit near water.
2. Never use aggressive cleaners on the casing or on the LCD screen. Remove dust, dirt and fingerprints with a soft, dry and non-abrasive cloth. More persistent dirt can be removed with a slightly damp cloth using only water. Disconnect all cables while doing this. Only reconnect them when the product is safely dry.
3. To avoid scratches or damage, never use sharp objects near the casing or the LCD screen. Avoid applying any pressure to the screen itself.
4. Install in accordance with the manufacturer's instructions. Make sure you place the unit on a stable surface before use. If you mount the unit in a rack, be sure to tighten all four screws in the rack mount holes.
5. Connect the unit to an easily accessible electrical outlet close to the unit.
6. When transporting the unit, use accessories recommended by the manufacturer or the original box and padding.
7. Do not install near any heat sources such as radiators, heat registers, stoves, or any other equipment (including amplifiers) producing heat.
8. Do not put the PL-2 Protective Cover (Elektron accessory) on the unit while the unit is powered on.
9. Do not block the ventilation holes located on the side and the bottom of the enclosure of the unit. Make sure there is sufficient air circulation in the room where the unit is kept.
10. This product, by itself or in combination with amplifiers, headphones or speakers, is capable of producing sound levels that may cause permanent hearing loss. Do not operate at a high volume level or at a level that is uncomfortable.
11. Protect the power cord from being walked on or pinched particularly at plugs, convenience receptacles, and the point where they exit from the unit.
12. Use attachments/accessories specified by the manufacturer.
13. Unplug this unit during lightning storms or when it is not used for long periods of time.
14. Refer all servicing to qualified service technicians. Servicing is required when the unit has been damaged in any way, liquid has been spilled or objects have fallen into the unit, the unit has been exposed to rain or moisture, does not operate normally, or has been dropped.

WARNING

To reduce the risk of fire, electrical shock or product damage:

- Do not expose the unit to rain, moisture, dripping or splashing and also avoid placing objects filled with liquid, such as vases, on the unit.
- Do not expose the unit to direct sunlight, nor use it in ambient temperatures exceeding 30°C as this can lead to malfunction.
- Do not open the casing. There are no user repairable or adjustable parts inside. Leave service and repairs to trained service technicians only.

SOUND PEAKS

- A brief 3 kHz signal will be sent to all outs of the Analog Rytm when the Test mode on the Early Startup menu is activated. Remember to turn down the volume on all speakers and headphones before activating Test mode.
- During calibration there will be loud and unpleasant sounds on the individual outs. Disconnect these during calibration.

SAFETY INSTRUCTIONS FOR THE POWER ADAPTER

- The adapter is not safety grounded and may only be used indoors.
- To ensure good ventilation for the adapter, do not place it in tight spaces. To prevent risk of electric shock and fire because of overheating, ensure that curtains and other objects do not prevent adapter ventilation.
- Do not expose the power adapter to direct sunlight, nor use it in ambient temperatures exceeding 40°C.
- Connect the adapter to an easily accessible electrical outlet close to the unit.
- The adapter is in standby mode when the power cord is connected. The primary circuit is always active when the cord is connected to the power outlet. Pull out the cord to completely disconnect the adapter.
- In the EU, only use CE approved power cords.

TABLE OF CONTENTS

1. INTRODUCTION	8
1.1 CONVENTIONS IN THIS MANUAL.....	8
2. THE ANALOG RYTM	9
3. PANEL LAYOUT AND CONNECTORS	10
3.1 FRONT PANEL	10
3.2 REAR CONNECTORS.....	12
3.3 SETTING UP AND STARTING THE ANALOG RYTM	12
4. ANALOG RYTM SOUND ARCHITECTURE	13
4.1 VOICE CIRCUITS	13
4.2 MACHINES	13
5. OVERVIEW OF THE ANALOG RYTM DATA STRUCTURE	14
5.1 +DRIVE	14
5.2 DATA STRUCTURE.....	14
5.2.1 PROJECT	14
5.2.2 KITS	14
5.2.3 SOUNDS	14
5.2.4 SAMPLES	14
5.2.5 PATTERNS	14
5.2.6 SONGS	15
5.2.7 GLOBALS	15
5.3 ABOUT THE TRACKS	15
5.3.1 THE DRUM TRACKS.....	15
5.3.2 THE FX TRACK.....	15
5.3.3 EDITING THE TRACKS.....	15
6. INTERACTING WITH THE ANALOG RYTM	16
6.1 SCREEN NAVIGATION	16
6.2 PARAMETER EDITING	16
6.2.1 QUICK PARAMETER EDITING	16
6.2.2 PARAMETER VALUE JUMP.....	16
6.2.3 [FUNCTION] KEY PRESS COMBINATIONS	16
6.3 QUICK SCROLLING	17
6.4 COPY, CLEAR AND PASTE	17
6.5 THE NAMING SCREEN	17
6.5.1 POP-UP NAMING.....	17
6.6 OVERBRIDGE.....	17
6.7 BACKING UP THE ANALOG RYTM	18
6.7.1 BACKING UP PROJECTS, SOUNDS, AND SAMPLES	18
6.7.2 TRANSFERRING BACKED UP FILES TO YOUR ELEKTRON DEVICE.....	18
7. QUICK START	19
7.1 PLAYING THE FACTORY PRESETS	19
7.1.1 PERFORMANCE MODE	19
7.1.2 SCENE MODE.....	19
7.1.3 CHROMATIC MODE	19
7.1.4 MUTE MODE.....	20
7.1.5 TEMPO	20
7.1.6 SETTING PARAMETERS.....	20
8. ANALOG RYTM CONTROLS	21

8.1 PADS	21
8.2 MACHINES	22
8.3 ROTARY ENCODERS	22
8.4 PRAGMATIC OPERATION	22
8.5 KEY BEHAVIOR	22
8.6 MIDI NOTES	22
8.7 MODE KEYS	23
8.7.1 MUTE MODE	23
8.7.2 CHROMATIC MODE	23
8.7.3 SCENE MODE	23
8.7.4 PERFORMANCE MODE	23
9. PROJECTS	25
9.1 PROJECT MENU	25
10. KITS AND SOUNDS	27
10.1 THE +DRIVE SOUND LIBRARY AND THE SOUND POOL	27
10.2 KIT MENU	27
10.3 SCENE MODE	28
10.3.1 SCENE EDIT	28
10.4 PERFORMANCE MODE	29
10.4.1 PERFORMANCE EDIT	30
10.5 SOUND MENU	31
10.5.1 SOUND BROWSER	31
10.5.2 SOUND MANAGER	32
10.6 PLAYING A SOUND	34
10.7 EDITING A SOUND	34
10.8 SELECTING A SAMPLE	35
10.9 EDITING THE FX	35
11. THE SEQUENCER	37
11.1 BASIC PATTERN OPERATIONS	37
11.1.1 SELECTING A PATTERN	37
11.1.2 PATTERN CONTROL	37
11.1.3 TEMPO	38
11.2 PATTERN MODES	38
11.3 EDITING A PATTERN	38
11.3.1 TRIG TYPES	38
11.3.2 GRID RECORDING MODE	39
11.3.3 LIVE RECORDING MODE	39
11.3.4 STEP RECORDING MODE	39
11.4 RETRIG MENU	40
11.5 TRACK MENU	41
11.6 PATTERN MENU	42
11.7 TRIG MENU	42
11.7.1 TRIGS SETUP MENU	43
11.8 CLICK TRACK	43
11.9 SCALE MENU	43
11.9.1 NORMAL MODE	44
11.9.2 ADVANCED MODE	44
11.10 SEQUENCER FEATURES	45
11.10.1 PARAMETER LOCKS	45
11.10.2 SOUND LOCKS	45

TABLE OF CONTENTS

11.10.3	CONDITIONAL LOCKS	45
11.10.4	TRIG MUTE	46
11.10.5	ACCENT	47
11.10.6	SWING	47
11.10.7	SLIDE	48
11.10.8	COPY, PASTE AND CLEAR OPERATIONS	48
11.10.9	QUICK SAVE AND RELOAD COMMANDS	48
12.	CHAINS AND SONGS	50
12.1	CHAINS	50
12.2	SONGS	50
12.2.1	SONG EDIT MENU	50
12.2.2	ADDING SONG ROWS AND ASSIGNING PATTERNS AND CHAINS	51
12.2.3	ADDING REPEATS AND MUTES	51
12.2.4	SONG MENU	52
13.	GLOBAL MENU	53
13.1	PROJECT	53
13.2	SAMPLES	53
13.2.1	LOADING, UNLOADING OR REPLACING A SAMPLE	53
13.2.2	REMOVING UNUSED SAMPLES FROM RAM	54
13.2.3	TRANSFERRING SAMPLES FROM A COMPUTER TO ANALOG RYTM	54
13.2.4	CREATING A NEW DESTINATION DIRECTORY	55
13.2.5	TRANSFERRING SAMPLES TO A COMPUTER FROM ANALOG RYTM	55
13.3	GLOBAL SLOT	55
13.4	MIDI CONFIG	55
13.4.1	SYNC	55
13.4.2	PORT CONFIG	56
13.4.3	CHANNELS	57
13.5	SYSEX DUMP	57
13.5.1	SYSEX SEND	58
13.5.2	SYSEX RECEIVE	58
13.6	AUDIO ROUTING	59
13.7	CONTROL	59
13.7.1	SEQUENCER CONFIG	59
13.8	SYSTEM	60
13.8.1	USB CONFIG	60
13.8.2	OS UPGRADE	60
13.8.3	FORMAT +DRIVE	60
13.8.4	CALIBRATION	61
13.8.5	VERIFY FACTORY SAMPLES	61
14.	STARTUP MENU	62
14.1	TEST MODE	62
14.2	EMPTY RESET	62
14.3	FACTORY RESET	62
14.4	OS UPGRADE	62
15.	SETUP EXAMPLES	64
15.1	ANALOG RYTM WITH A MONOPHONIC BASS MACHINE	64
15.2	ANALOG RYTM WITH OTHER ELEKTRON GEAR	64
15.3	ANALOG RYTM WITH A STEREOHONIC DRUM MACHINE	65
16.	USEFUL KEY COMBINATIONS (QUICK KEYS)	67
	NAMING	67

SEQUENCER SETTINGS	67
17. TECHNICAL INFORMATION	69
18. CREDITS AND CONTACT INFORMATION	71
18.1 CREDITS	71
18.2 CONTACT INFORMATION	71
APPENDIX A: DRUM TRACK PARAMETERS	72
A.1 SYNTH	72
A.2 SAMPLE	72
A.3 FILTER	73
A.4 AMP	73
A.5 LFO	74
APPENDIX B: FX TRACK PARAMETERS	75
B.1 DELAY	75
B.2 REVERB	75
B.3 DISTORTION	76
B.4 COMPRESSOR	76
B.5 FX LFO	77
APPENDIX C: MIDI	79
C.1 GENERAL TRIG PARAMETERS	79
C.2 GENERAL KIT PARAMETERS	79
C.3 PERFORMANCE PARAMETERS	79
C.4 GENERAL SYNTH PARAMETERS	79
C.5 LFO PARAMETERS	81
C.6 FX PARAMETERS	81
C.7 MACHINE PARAMETERS	82
APPENDIX D: MACHINES	89
D.1 ALL	89
D.2 BASS DRUM	90
D.3 SNARE DRUM	92
D.4 RIMSHOT	93
D.5 HAND CLAP	94
D.6 DUAL VCO	94
D.7 BASS TOM	95
D.8 LOW, MID, HIGH TOM	95
D.9 CLOSED HIHAT	95
D.10 OPEN HIHAT	96
D.11 CYMBAL	97
D.12 COWBELL	98
INDEX	99

1. INTRODUCTION

Thank you for purchasing Analog Rytm. It is a hybrid analog/digital drum machine featuring, among many other things, the intuitive Elektron step sequencer. The innovative combination of modern technology and tried and trusted ways of sound generation lets you create any kind of drum: purely analog, sample-based or a combination of the two. To get the most out of your machine, we recommend that you read this manual in its entirety.

1.1 CONVENTIONS IN THIS MANUAL

We have used the following conventions throughout the manual:

Key names are written in upper case, bold style and bracketed letters. For instance, the key labeled “function” on the main panel is called **[FUNCTION]**.

Menu names are written in upper case letters. The OSC 1 menu is an example of that.

Parameter names and certain menu options where settings can be made or actions performed are written in bold, upper case letters. For example, **VOL**.

Upper case letters are used for parameter setting alternatives, for example, OFF, and certain menu settings, like LEGATO.

Messages visible on the screen are written in upper case letters with quotation marks. Like this, “BANK A: CHOOSE PTN.”

Knobs are written in upper case, bold, italic letters. For instance, the knob “level” is called ***LEVEL***.

LED indicators like the record LED are written like this: <RECORD>.

The following symbols are used throughout the manual:



Important information that you should pay attention to.



A tip that will make it easier for you to interact with the Analog Rytm



This symbol shows a nice ear. For the first time in Elektron history, it is used in the manual. It is up to you to find out where.

2. THE ANALOG RYTM

There is geometry in the humming of the string.

There is music in the spacing of the spheres. (Pythagoras, circa 530 BC)

A long time ago, the son of a Samian carpenter discovered that harmonic sounds were produced when fretting a vibrating string at certain geometric points. During his travels in the Far East he learned and understood the interconnectedness of all things. Phenomena in the heavens above and in the vegetable patch below were not intrinsically different. The proportion and spacing of natural elements like the moons of planets, the seeds of a sunflower or the dimensions of a well-crafted bow were all curiously - musical. Octaves, multiples of octaves, fifths and other musical ratios seemed to be at the core of all things, large and small alike. And the fundamental building block of all this was Number.

He went on to found the first school of discrete mathematics in Croton on the southern tip of Italy. Many aspects of the natural world that awed and inspired him may have seemed random and impossible to grasp. Yet any complexity, he realized, could be made to reveal its hidden grain and understood if probed by mathematics. Once the structure was found, it was possible to recreate and further investigate the natural phenomena using digital computation and geometric visualization.

We would boldly like to claim that the Drum Computer we call Analog RytM embodies and honors the spirit of Pythagoras: combining the fearless hands-on strumming of nature's vibrating strings with the cool analytic framework of digital computation. Making sure you are always in control. Analog and digital - the two are not destined to be forever separated. At last the great divide will be bridged. By you.

Whether the musical world you choose to inhabit is an ordered, harmonious and intelligible one or one of disharmony, chaos and earth-shattering noise, the Analog RytM will be your guide, companion and work-horse. It is our firm belief that you will have as much fun using the machine as we have had developing it. Enjoy.

The Elektron Team

Analog RytM MKI User Manual This manual is copyright © 2022 Elektron Music Machines MAV AB. All reproduction without written authorization is strictly prohibited. The information in this manual may change without notice. Elektron's product names, logotypes, titles, words or phrases may be registered and protected by Swedish and international law. All other brand or product names are trademarks or registered trademarks of their respective holders. This manual for Analog RytM OS version 1.61E, was last updated Februari 2, 2022.

3. PANEL LAYOUT AND CONNECTORS

3.1 FRONT PANEL

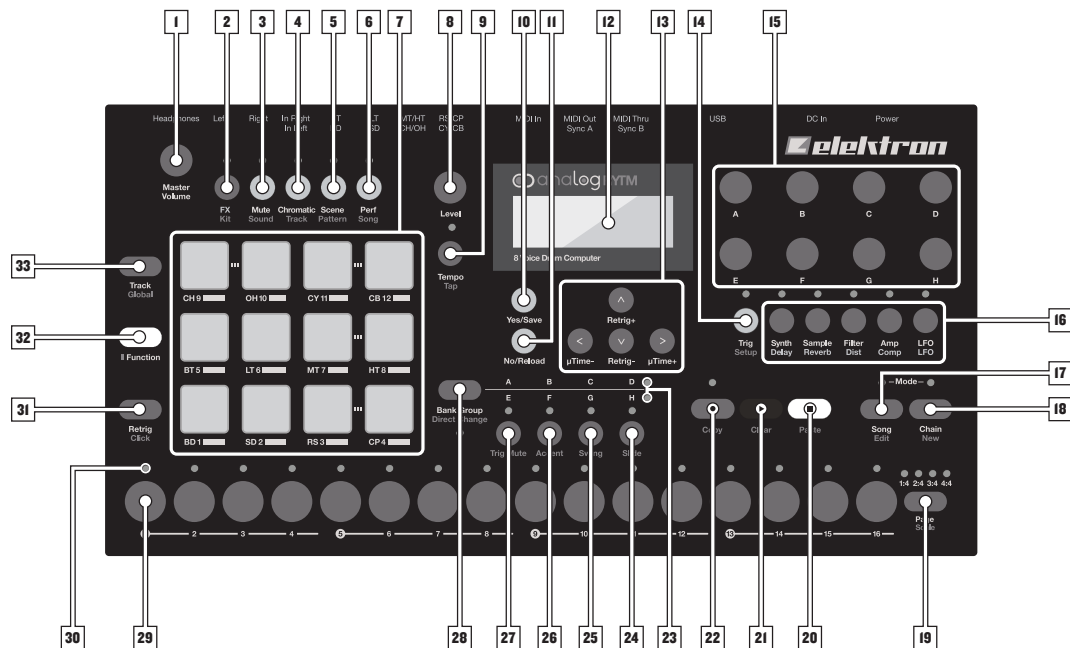

The Analog Rytm Front Panel.

1. **MASTER VOLUME** sets the volume for the main outputs and the headphones output.
2. **[FX]** selects the FX track. Secondary function accesses the KIT menu.
3. **[MUTE]** activates MUTE mode. SOUND menu is accessed as a secondary function.
4. **[CHROMATIC]** activates CHROMATIC mode, in which the pads are used to play the current track Sound chromatically across four octaves. Secondary function accesses the TRACK menu.
5. **[SCENE]** activates SCENE mode, in which a one-push instant change of an array of parameter settings is possible. Secondary function brings forth the PATTERN menu.
6. **[PERF]** activates PERFORMANCE mode. Secondary function accesses the SONG menu.
7. **[PADS]** are 12 responsive, assignable, velocity and pressure sensitive synthetic rubber pads with after-touch. They have many possible functions depending on which mode is active and what each pad is set to do. First of all, they are designed to play the track Sounds. Each drum track has a dedicated pad (see the complete map on page 21). <PADS> will exhibit a variety of colors.
8. **LEVEL** sets the overall volume level of the active track. Also used for setting parameters and scrolling through lists.
9. **[TEMPO]** opens the TEMPO menu. **[FUNCTION] + [TEMPO]** makes it possible to tap the tempo.
10. **[YES/SAVE]** key. Used for entering sub-menus, selecting and confirming. If pressed in combination with 2, 3, 4, 5 or 6 above it will instantly save the kit, Sound, track, pattern or song.
11. **[NO/RELOAD]** key. Used for exiting an active menu, backing one step and negating. If pressed in combination with 2, 3, 4, 5 or 6 above it will instantly reload the kit, Sound, track, pattern or song.
12. The LCD screen.
13. The **[ARROW]** keys. Used for navigation and for setting some parameter values. In menus, they are called **[UP]**, **[DOWN]**, **[LEFT]** and **[RIGHT]**.
14. **[TRIG SETUP]** key controls the TRIG settings for the active track. Secondary function accesses the TRIGS SETUP menu.
15. **DATA ENTRY** knobs **A-H**. Used for setting parameter values. Press knob when turning to change values in larger increments.

16. **[PARAMETER]** keys access the PARAMETER pages of the active track. <PARAMETER> LEDs directly above the keys indicate if the page is active (red) or inactive (off). The five parameter page keys are, from left to right:
 - SYNTH** key accesses the SYNTH parameters of the track Sound. These control the drum synthesis. When the FX track is active, the DELAY parameter page is accessed.
 - SAMPLE** key takes you to the SAMPLE pages. Various aspects of the sample playback are set on these pages. When the FX track is active, the REVERB parameter page is accessed.
 - FILTER** key accesses the FILTER page. The analog multimode filter parameters are set here. When the FX track is active, the DISTORTION parameter page is accessed.
 - AMP** key takes you to the AMP page, where the shape of the amplitude envelope is set. When the FX track is active, the COMPRESSOR parameter page is accessed.
 - LFO** key accesses the LFO parameters for the active track.
17. **[SONG MODE]** activates/deactivates SONG mode. The secondary function is SONG edit.
18. **[CHAIN MODE]** activates/deactivates CHAIN mode. The secondary function initiates a new CHAIN.
19. **[PAGE]** selects the active pattern page, if the pattern is made of more than 16 steps. <PATTERN PAGE> LEDs indicate how many pattern pages the active pattern consists of and which pattern page is currently active. The LED flashes on the pattern page currently playing. The secondary function accesses the SCALE menu. Pressing this key also activates Fill Mode (when GRID RECORDING mode is not active).
20. **[STOP]** stops playback. The secondary function is a paste operation.
21. **[PLAY]** starts the playback of the sequencer. The secondary function is a clear operation.
22. **[RECORD]** key. Activates/deactivates GRID RECORDING mode. Press **[RECORD] + [PLAY]** to activate LIVE RECORDING mode. Press **[RECORD] + [STOP]** to activate STEP RECORDING mode. The secondary function is a copy operation.
23. <BANK GROUP> LED indicates if bank group A-D or E-H will be accessed by the **[BANK]** keys.
24. **[BANK D/H]** accesses pattern selection for either bank D or H. The secondary function is SLIDE.
25. **[BANK C/G]** accesses pattern selection for either bank C or G. The secondary function is SWING.
26. **[BANK B/F]** accesses pattern selection for either bank B or F. The secondary function is ACCENT.
27. **[BANK A/E]** accesses pattern selection for either bank A or E. The secondary function is TRIG MUTE.
28. **[BANK GROUP]** key. Toggles the active bank group, A-D or E-H. The secondary function toggles between different PATTERN play modes (DIRECT JUMP/SEQUENTIAL/DIRECT START). The <PATTERN MODE> LED, directly below this key, shows these modes as green, off and red, respectively.
29. **[TRIG]** keys are used for entering or removing sequencer trigs, in combination with the **[PADS]**, and parameter locks, in combination with the **DATA ENTRY** knobs. Also used to select a pattern, when one of the **[BANK]** keys has been pressed.
30. <TRIG> LEDs show trigs on the sequencer by a fully lit LED, while parameter locks are shown as flashing LEDs, in GRID RECORDING mode. When a pattern is playing, or when LIVE RECORDING is enabled, a fully lit LED “runs” along the 16 steps of the sequencer across all (up to four) pages at the set TEMPO.
31. **[RETRIG]** key will if pressed in combination with one of the **[PADS]**, continuously retrig the Sound. It also lets you assign custom retrigs for each of the drum tracks on a side menu appearing on the LCD screen whenever the key is pressed. The secondary function opens the CLICK TRACK menu.
32. **[FUNCTION]** key. Press, hold and press another key to access the secondary function of that key. Secondary functions are seen in red writing on the Analog Rytm front panel.
33. **[TRACK]** key. Press **[TRACK] + one of the [PADS]** to select a drum track for editing or CHROMATIC play. Note that the FX track has a separate dedicated key. The secondary function opens the GLOBAL menu where the global settings (SYNTH, SEQUENCER, MIDI et cetera) for the current PROJECT are made. PROJECTS and SAMPLES are managed in the GLOBAL menu as well.

3.2 REAR CONNECTORS

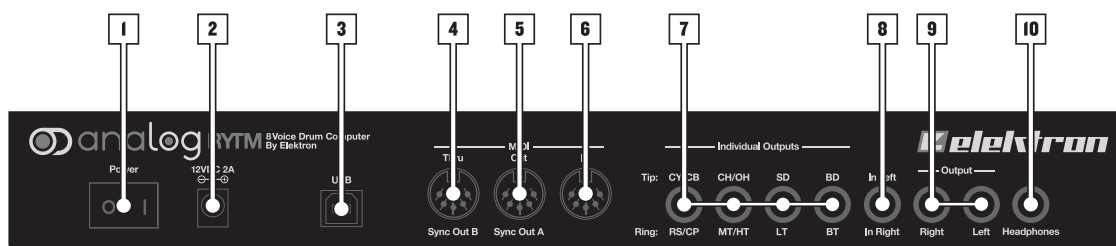

The Analog Rytm Rear Connectors.

1. **Power On/Off switch.**
2. **Power In (12V DC 2A).** Use the included PSU-3 power adapter, or equivalent, connected to a power outlet.
3. **Full-speed USB 2.0.** Connect to a computer host using the included A to B USB 2.0 connector cable.
4. **MIDI Thru.** Use standard MIDI cable to connect another MIDI unit in the chain. Duplicates incoming MIDI In data stream. Can also be configured to send DIN sync to legacy instruments.
5. **MIDI Out.** Use standard MIDI cable to connect to MIDI In of an external MIDI unit. Can also be configured to send DIN sync to legacy instruments.
6. **MIDI In.** Use standard MIDI cable to connect MIDI Out of an external MIDI unit for it to control the Analog Rytm.
7. **Individual drum voice outputs CY/CB - RS/CP, CH/OH - MT/HT, SD - LT and BD - BT.** Use 1/4" insert/Y cable to access both voices of each output.
8. **Audio In.** Use 1/4" stereo (Tip/Ring/Sleeve) phone plug to input stereo sound from an external source.
9. **Main Out L/R.** Use either 1/4" mono phone plug (unbalanced connection) or 1/4" (Tip/Ring/Sleeve) phone plug (balanced connection).
10. **Headphones Out.** Connect standard headphones with 1/4" stereo phone plug.

3.3 SETTING UP AND STARTING THE ANALOG RYTM

Make sure you place the Analog Rytm on a stable support, such as a sturdy table with sufficient cable space or mount on a rack capable of a 3 kg load.

Before you connect the Analog Rytm to other equipment, make sure all units are switched off.

Plug the included PSU-3 adapter to a power outlet and insert the small plug into the Analog Rytm Power In.

Connect the Main Out L/R from the Analog Rytm to your mixer or amplifier.

If MIDI control is desired, connect the MIDI OUT port of the device you wish to send data from to the MIDI IN port of the Analog Rytm. The MIDI THRU port duplicates the data arriving at the MIDI IN port. It is used for chaining several MIDI units together.

Switch on all units. Switch on the Analog Rytm by pressing the Power rocker switch located at the back of the unit. Before restarting the unit, wait 2 seconds after the LCD backlight goes out.

4. ANALOG RYTM SOUND ARCHITECTURE

The Analog RytM sound architecture, with its eight drum voices, two send effects (delay and reverb), and two master effects (distortion and compressor), is shown below. Analog elements are gray; digital are white.

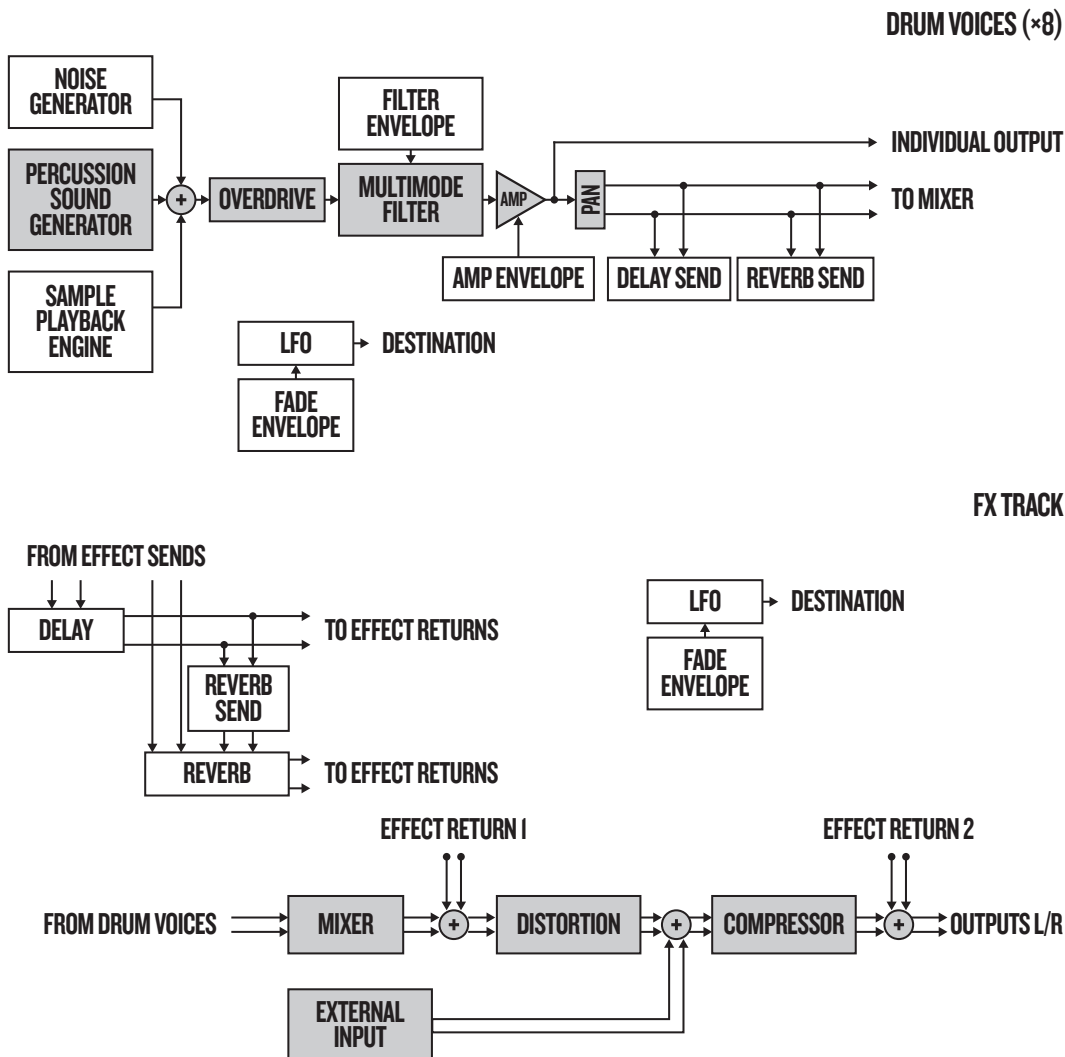

4.1 VOICE CIRCUITS

There are eight analog voice circuits. All voices have an identical sample playback engine, overdrive circuit, and multimode filter. The percussion sound generators are not identical. Each is designed to generate a specific class of analog drum sounds.

4.2 MACHINES

There are several MACHINES available for each voice circuit. A MACHINE is a set of synthesis parameters that controls a percussion sound generator in order to act like a certain drum model. Different MACHINES are software tailored to generate different kinds of bass drums, hi-hats, et cetera - and to provide the parameters most apt for each particular MACHINE. Per default, the **BD** voice makes use of one of the available bass drum MACHINES, **BDHD**. Another MACHINE may be selected which will engage the **BD** voice circuit in a different way, enabling it to employ, for example, frequency modulation.

5. OVERVIEW OF THE ANALOG RYTM DATA STRUCTURE

The image below outlines the data structure of the Analog RytM.

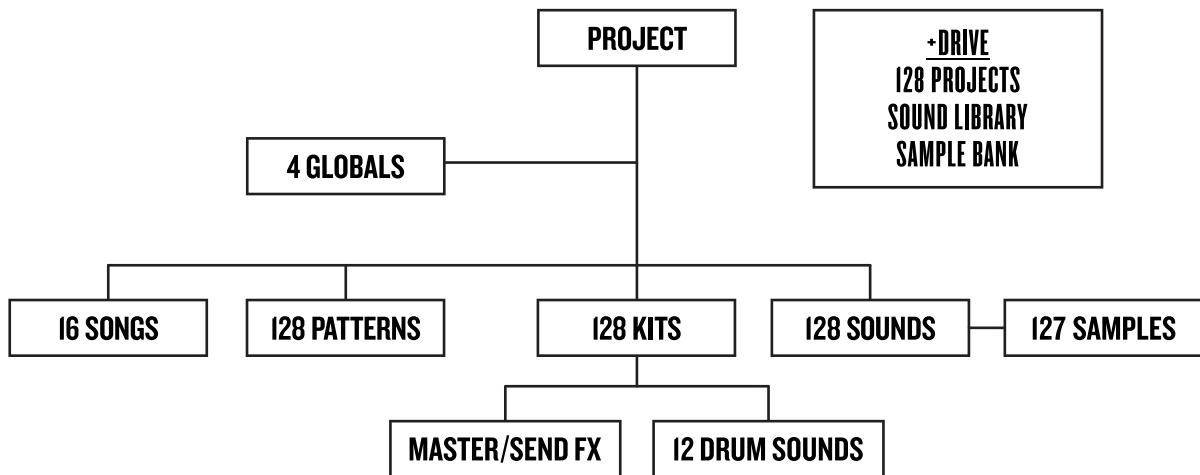

5.1 +DRIVE

The +Drive is a non-volatile storage. It keeps up to 128 projects (thousands of patterns, kits and songs) stored internally. The +Drive also contains the +Drive Sound library, capable of storing 4096 drum Sounds, and the Sample bank. All projects have access to these Sounds and samples.

5.2 DATA STRUCTURE

5.2.1 PROJECT

A project contains 128 patterns, 128 kits, 16 songs, 4 global slots, 127 sample slots and a project Sound pool consisting of up to 128 Sounds. General settings and states are stored in the project. When a project is loaded it becomes the active working state of the Analog RytM. From here it is possible to edit the patterns, kits, songs and globals of the project. Every time the Analog RytM is switched on, it boots to the active working state, the active project. Projects are saved, loaded and managed in the GLOBAL menu. Read more about projects in the section “9. PROJECTS” on page 25.

5.2.2 KITS

A kit is a collection of twelve drum track Sounds and the FX track parameter settings. When editing a track, changes made to the parameter settings will be stored in the active kit. Each project of the Analog RytM contains 128 individual kits. A pattern always links to one of the kits. Read more in the section “10. KITS AND SOUNDS” on page 27.

5.2.3 SOUNDS

A Sound consists of the parameter settings found in the PARAMETER pages called SYNTH, SAMPLE, FILTER, AMP and LFO. Sounds are stored in the Sound pool of the active project or in the +Drive Sound library. The Sound pool has 128 Sound slots and the +Drive Sound library holds up to 4096 sounds. Read more in the section “10. KITS AND SOUNDS” on page 27.

5.2.4 SAMPLES

127 user sample slots are available for each project. There are many preset samples to choose from in the +Drive Sample bank. Additional samples need to be transferred to the Analog RytM from a computer with the complimentary C6 utility software. See section “13. GLOBAL MENU” on page 53.

5.2.5 PATTERNS

For each of the 8 banks 16 patterns are available, which means 128 patterns are always readily available for each project. A pattern contains sequencer data like drum trigs, trig mutes and parameter locks for the drum tracks and the FX track, as well as default settings on the TRIG page and length, swing and time signature settings. Read more in the section “11. THE SEQUENCER” on page 37.

5.2.6 SONGS

16 songs are available for each project. They are used to sequence the playback of patterns. Songs are built of patterns and chains. Read more about songs in the section “12.2 SONGS” on page 50.

5.2.7 GLOBALS

The GLOBAL settings contain overarching settings for the sequencer, MIDI, and global track routing. Four global slots are available for each project, each with its own specific settings. Read more about the global settings in the section “13. GLOBAL MENU” on page 53.

5.3 ABOUT THE TRACKS

5.3.1 THE DRUM TRACKS

There are 12 drum tracks. To select a track for editing, press and hold **[TRACK]** key and then press one of the **[PADS]**. Each drum track uses a specific drum voice controlled by one of the MACHINES available for the voice. All drum tracks can layer analog percussion sounds and sampled sounds, to distort and filter them, and apply a dedicated LFO each.

5.3.2 THE FX TRACK

The FX track controls the Analog RytM send effects DELAY and REVERB, as well as the DISTORTION and COMPRESSOR master effects. One LFO is also available for this track. To select the FX track for editing, press the **[FX]** key.

5.3.3 EDITING THE TRACKS

The five **[PARAMETER]** keys open parameter pages that are used for editing the tracks. The SYNTH page of a drum track contains different parameters depending on the MACHINE chosen for the analog percussion sound generator. The other pages are identical for all drum tracks; the SAMPLE page for the sample playback engine, the FILTER page for the multimode filter and its filter envelope, the AMP page for the amplitude envelope and effect sends, and the LFO page for the low-frequency oscillator. The corresponding five parameter pages for the FX track controls the four effects and the FX LFO. Edit parameters using the **DATA ENTRY** knobs **A-H**. Press and turn a knob to adjust its parameter in larger increments.

6. INTERACTING WITH THE ANALOG RYTM

The LCD screen shows all the information needed for real-time interaction and editing on the Analog RytM. The eight *DATA ENTRY* knob parameters shown will vary depending on the given situation. The main interface screen is shown below:

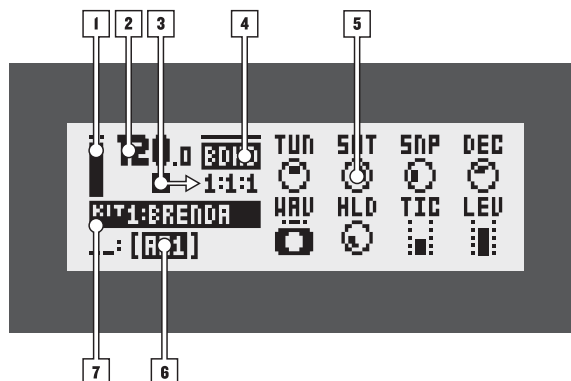

1. Bar showing the main volume setting of the active track. Turn *LEVEL* knob to change.
2. The current tempo shown with one decimal.
3. The playback/recording status of the sequencer shown with the standard “record”, “play”, “pause” and “stop” symbols; ■, ▶, ||, and ■. To the right is a counter displaying how many bars, beats, and steps the sequencer has played.
4. Shows the current PARAMETER page name.
5. Eight track parameters. They show what the *DATA ENTRY* knobs control and their current parameter values. Press and turn a knob to adjust its parameter in larger increments.
6. The active pattern.
7. The active kit. When turning a *DATA ENTRY* knob, the full name of the parameter is shown here. When the active track is changed, the name of the track Sound is briefly shown.

6.1 SCREEN NAVIGATION

When entering a menu or sub-menu, navigation is done using the [ARROW] keys [UP], [DOWN], [LEFT] or [RIGHT]. The *LEVEL* knob can be used to quickly scroll through menus and lists.

[YES/SAVE] is used to affirm, select, enter sub-menus and tick/untick boxes.

[NO/RELOAD] is used to negate, deselect or go back one or more steps.



When on a menu or sub-menu the [NO/RELOAD] key can be used to go back, one step at a time, all the way to the main screen.

6.2 PARAMETER EDITING

The *DATA ENTRY* knobs are used to change the value of the track parameters. The position of the parameters on the LCD screen correspond to the physical location of the knobs on the front panel.

6.2.1 QUICK PARAMETER EDITING

If the *DATA ENTRY* knob is pressed when it is turned parameters will be adjusted in larger increments. Quickly sweep through a whole parameter range in this manner.

6.2.2 PARAMETER VALUE JUMP

Pressing [FUNCTION] while editing certain parameters will make the parameter values jump to appropriate positions. The time of the Delay, for example, will jump between 16, 32, 64 and 128 and the oscillator tuning will jump whole octaves.

6.2.3 [FUNCTION] KEY PRESS COMBINATIONS

The standard way to use the [FUNCTION] key in combination with other keys, is to press and hold [FUNCTION] and then make a short press on the second key in the combination. For some key combinations it is also possible to access a sub-menu by pressing and holding [FUNCTION] + second key for a second.

6.3 QUICK SCROLLING

Scroll through menus using the *LEVEL* knob. Quick scrolling is possible on many menus. Press [FUNCTION] + the [UP] or [DOWN] arrow keys to move the cursor one menu page at a time.

6.4 COPY, CLEAR AND PASTE

Copy, clear and paste commands are available in a lot of contexts. A copy operation is performed by pressing [FUNCTION] + [REC]. A paste operation is performed by pressing [FUNCTION] + [STOP]. A clear operation is performed by pressing [FUNCTION] + [PLAY]. Paste and clear operations can be undone by repeating the key press combination. See the different sections in the manual for more information on when these commands are applicable.

6.5 THE NAMING SCREEN

The naming method is identical for the various naming situations that appear when kits, Sounds, songs, projects et cetera are saved or renamed. This screen is also used for text searches.

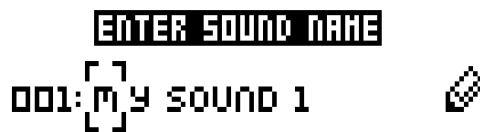

The [LEFT] and [RIGHT] arrow keys are used to navigate between the characters. Turning the *LEVEL* knob or pressing the [UP] or [DOWN] arrow keys cycles between the characters. [FUNCTION] + [NO/RELOAD] will erase letters.

6.5.1 POP-UP NAMING

A convenient way of naming is to open a pop-up menu that shows all available letters, symbols, and digits. When on the NAMING screen, press the [FUNCTION] key.



Keep [FUNCTION] pressed and use the [ARROW] keys to highlight the character you want to insert. Once there, release [FUNCTION] to insert the character.



Copy, paste, and clear commands are available on the naming screen.

6.6 OVERBRIDGE

This manual primarily focuses on how to use the Analog Rytm as a standalone effect. But you can also use Overbridge to interact with the Analog Rytm. The Overbridge software suite enables a tight integration between the Elektron Rytm and a computer DAW.

When using the Overbridge setup, the user interface for your Elektron device will present itself as a clearly laid out plug-in window in your DAW. Enjoy multitrack audio, browse through and organize sounds and samples, edit kits, and set up scene and performance macros via a simple point-and-click workflow. Access, edit, or automate all parameters for sound shaping and sample manipulation, for each of the distinctive tracks, on screen. Always find your device settings in the same state as you left them when you return to your DAW project, with the convenient, Machine State Total Recall functionality.

You need an Analog Rytm, a USB cable, a computer running Overbridge, and a DAW.

If you want to hook up multiple machines to a computer, you must use a USB hub. We suggest the Elektron Overhub, tailored for Overbridge use. It is Multi-TT hub and thereby also supports older Elektron machines.

Overbridge is available for download on the Elektron website. Please read the Overbridge manual (also available on the Elektron website, Support section) to learn more about its uses and capabilities.

Once installed, for Overbridge to work together with your Analog Rytm, do the two following two things:
First - Make sure the OS of your Analog Rytm, and the OS of Overbridge, match. You must have the most recent OS installed for both Overbridge and the device. The most recent OS versions are available for download on the Elektron website.

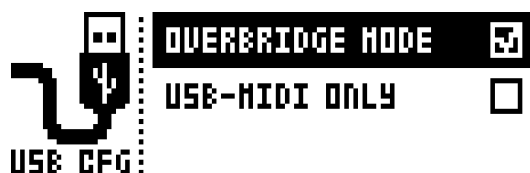

Second - set your Analog Rytm device to Overbridge mode on the USB CONFIG page. You will find this setting in the SYSTEM menu, located in the GLOBAL menu. Press [YES/SAVE] to tick the box and activate OVERBRIDGE MODE.

6.7 BACKING UP THE ANALOG RYTM

It is always recommended to make regular backups of your data. Backups are also a convenient way to share your projects, Sounds, and samples with other users. To make backups and transfer files to and from your Elektron device, you should use Transfer, a free application that you can download from the Elektron site <https://www.elektron.se/support>. The application is available for both Windows and macOS.

6.7.1 BACKING UP PROJECTS, SOUNDS, AND SAMPLES

You can backup up your projects, sounds, and samples from your Elektron device to a computer. Here is the general procedure for how to back up your device:

1. Connect the Elektron device to the computer via USB.
2. Open the Transfer application on your computer, and then select the USB MIDI port(s) for your device on the CONNECTION page, and then click "CONNECT" (or click "CONNECT" next to your device under PREVIOUSLY USED if it has been connected before).
3. In Transfer, click the EXPLORE tab to open the EXPLORE page.
4. On the EXPLORE page top left side of the drop-down menu, make sure "MY COMPUTER" is selected.
5. On the top right side, in the drop-down menu, select the type of file you want to transfer.
6. In the window on the right, navigate to the files or folders you want to transfer
7. Drag and drop the files or folders to your preferred location under "MY COMPUTER."

6.7.2 TRANSFERRING BACKED UP FILES TO YOUR ELEKTRON DEVICE

Use the EXPLORE page in Transfer to transfer previously backed up files to your Elektron device from a computer.

1. Connect the Elektron device to the computer via USB.
2. Open the Transfer application on your computer and then select the USB MIDI port(s) for your device on the Transfer CONNECTION page. Click "CONNECT" (or click "CONNECT" next to your device under PREVIOUSLY USED if it had been connected before).
3. In Transfer, click the EXPLORE tab to open the EXPLORE page.
4. On the top right side, in the drop-down menu, select the type of file you want to transfer.
5. On the top left side in the drop-down menu, make sure "MY COMPUTER" is selected.
6. Under "MY COMPUTER," navigate to the files or folders you want to transfer.
7. Drag and drop the files or folders to your preferred location on your device.
8. Depending on what file type you send, you might encounter pop-up windows asking you to decide what files you want to send and how you want to organize them.

7. QUICK START

This quick start will guide you through some of the basic operations to start using the Analog Rytm right away. First, connect it as described in section “3.3 SETTING UP AND STARTING THE ANALOG RYTM” on page 12.

7.1 PLAYING THE FACTORY PRESETS

You will find several preset patterns, kits, and Sounds in the Analog Rytm. Follow the instructions below to get started exploring your new instrument.

1. Switch on the Analog Rytm.
2. Make sure bank group A-D is selected. <BANK GROUP> LED must be lit in its upper position. If it is not, press the **[BANK GROUP]** key to toggle.
3. Press **[BANK A/E] + [TRIG]** key 1 to select the first pattern of bank A.
4. Press **[PLAY]** to listen to pattern A01.
5. Press **[BANK A/E] + [TRIG]** key 2 to select pattern A02. It will start once pattern A01 has reached its end. Select pattern A03 by pressing **[BANK A/E] + [TRIG]** key 3, and so on.
6. Press **[STOP]** to stop playback.

7.1.1 PERFORMANCE MODE

The PERFORMANCE mode enables each one of the twelve pads to control several PARAMETER page parameters at once. Change many dimensions of one or more drum track Sounds at the touch of a single pad. A set of such parameter locks is called a performance macro, shown with dim green <PADS>. Try out the preset macros:

1. Make sure a pattern is playing.
2. Press the **[PERF]** key to enter PERFORMANCE mode.
3. Press the dim green **[PADS]**. Apply different pressures and hear how the sound of the pattern changes.

7.1.2 SCENE MODE

The SCENE mode turns the twelve pads into instant sound shifters. Similar to a performance macro, several parameters from any track can be changed by pressing a single pad. A scene is a fixed set of parameter values, ready to be activated or deactivated, shown with dim blue <PADS>. Try out the preset scenes by following the instructions below. The active scene is shown with a bright blue color pad.

1. Make sure a pattern is playing.
2. Press the **[SCENE]** key to enter SCENE mode.
3. Tap one of the dim blue color **[PADS]** to activate a scene. Tap again to deactivate.

7.1.3 CHROMATIC MODE

Any track Sound may be played chromatically using the 12 pads. The chromatic note pitch is linearly increased for each successive pad pressed: left to right, bottom to top. Twelve successive pads make one octave. The range spans four octaves, middle, one up and two down. The middle octave has sky blue color <PADS>, the two below are of violet and dark blue color, in that order, and the one above is yellow.

1. Select the drum track to play chromatically by pressing **[TRACK] + one of the [PADS]**.
2. Press the **[CHROMATIC]** key to enter CHROMATIC mode.
3. Play the **[PADS]**. The active track Sound will be pitched differently for each of the 12 pads comprising the middle octave. Reach higher or lower octaves, one row at a time, by pressing **[ARROW]** keys **[UP]** or **[DOWN]**, respectively.



The CHROMATIC mode is an effective way to add musical variety to your beats. The timbre, tonality and impact of playing a Sound chromatically depend on the track type and how the Sound is designed. The synth part, the sample part or both synth and sample part of the Sound may be chromatic enabled. This is done in the SOUND SETTINGS, see “10.5 SOUND MENU” on page 31.

7.1.4 MUTE MODE

Mute the sequencer of any of the twelve drum tracks in this mode. Unlike the CHROMATIC mode, it makes no difference which track is active when this mode is activated. All tracks are accessed simultaneously.

1. Make sure a pattern is playing.
2. Press the **[MUTE]** key to enter MUTE mode.
3. Press any of the **[PADS]** to mute the corresponding track. Press again to unmute. The color of the <PADS> indicates the mute status. Unlit <PADS> are muted. Green <PADS> are audible.
4. Press and hold **[FUNCTION]** and then any of the **[PADS]** in order to preselect a mute, or mute/unmute several tracks in one go. Once you release **[FUNCTION]**, the selected mutes will come into effect. Preselected mutes are shown as <PADS> of sky blue color.



When MUTE mode is active, press **[RETRIG]** and one of the **[PADS]** if you wish to activate solo, in other words, mute all tracks except the one selected. Press again to deactivate solo. Keeping **[RETRIG]** pressed, multiple tracks may be solo activated/deactivated. Solo activated <PADS> are of turquoise color.

7.1.5 TEMPO

Press the **[TEMPO]** key to open the TEMPO screen where you can set the overall BPM speed.



Use the *LEVEL* knob to change tempo in steps of one BPM. Pressing the knob while turning it changes the tempo eight steps at a time. The **[ARROW]** keys **[UP]** or **[DOWN]** change the tempo steps of 0.1 BPM.



Note that you can choose between a project tempo (same tempo for all the patterns in a project) or use a separate tempo for every pattern. Press **[FUNCTION]** + **[YES]** to switch between PROJECT and PATTERN tempo mode.

To tap a tempo setting, press and hold the **[FUNCTION]** key and tap the **[TEMPO]** key in a steady rhythm. The average tempo of the taps calculates after four consecutive taps. For more information, please see “11.1.3 TEMPO” on page 38.

7.1.6 SETTING PARAMETERS

Each drum track has five PARAMETER pages, accessed by pressing **[PARAMETER]** keys SYNTH, SAMPLE, FILTER, AMP, and LFO. The parameters found here affect the sound in various ways. When the FX track is active, the corresponding PARAMETER pages are DELAY, REVERB, DISTORTION, COMPRESSOR and LFO, accessed by the same keys.

1. Make sure a pattern is playing.
2. Press **[TRACK]** + **[PADS]** 1-12 to select one of the twelve drum tracks.
3. To change, for example, the cutoff of the filter, press the **FILTER** key. The FILTER page will be shown on the LCD screen. The parameter labeled FRQ changes the cutoff of the filter. Turn *DATA ENTRY* knob **E** to change the parameter value, and hear how the Sound is affected.

Try out the rest of the PARAMETER page parameters to explore a variety of sound shaping possibilities.

To reload the Sound to its original state, press **[NO/RELOAD]** + **[MUTE]**.

To reload the whole kit to its original state, press **[NO/RELOAD]** + **[FX]**.

To save kit changes, press **[YES/SAVE]** + **[FX]**.

8. ANALOG RYTM CONTROLS

The Analog Rytm is played using the **[PADS]**. The responsive, velocity and pressure sensitive synthetic rubber pads can be assigned to perform many possible functions. <PADS> will exhibit a variety of colors. There are a variety of modes: MUTE mode, CHROMATIC mode, SCENE mode and PERFORMANCE mode.

8.1 PADS

The left half of the Analog Rytm front panel is dominated by the 12 pads. The finger-sized pads are made of tough synthetic rubber and respond to pressure. Tapping a pad will trigger its track sound. **BD** will trigger the bass drum, **SD** the snare drum and so on. The illustration outlines and briefly describes the analog percussion sound generators. The twelve tracks and their default MACHINES are shown below.

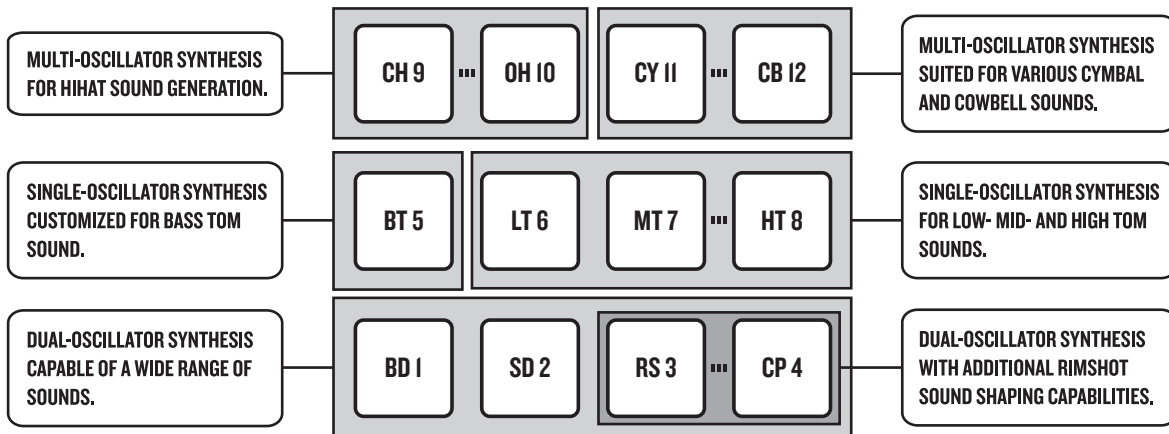

PAD

1. **BD** (Bass Drum)
2. **SD** (Snare Drum)
3. **RS** (Rim Shot)
4. **CP** (Hand Clap)
5. **BT** (Bass Tom)
6. **LT** (Low Tom)
7. **MT** (Mid Tom)
8. **HT** (Hi Tom)
9. **CH** (Closed Hihat)
10. **OH** (Open Hihat)
11. **CY** (Cymbal)
12. **CB** (Cow Bell)

MACHINES

1. HARD, CLASSIC, FM, PLASTIC, SILKY, SHARP, DUAL VCO
2. HARD, CLASSIC, FM, NATURAL, DUAL VCO
3. HARD, CLASSIC, DUAL VCO
4. CLASSIC, DUAL VCO
5. CLASSIC
6. CLASSIC
7. CLASSIC
8. CLASSIC
9. BASIC, CLASSIC, METALLIC
10. CLASSIC, METALLIC
11. CLASSIC, METALLIC, RIDE
12. CLASSIC, METALLIC

GENERAL MACHINES: NOISE, IMPULSE.

Play the track Sounds of the active kit using the **[PADS]**. 8 individual track Sounds can be voiced simultaneously with the eight physical voices of the Analog Rytm. The **BD**, **SD**, **BT** and **LT** are independent tracks with their individual voices. Tracks **RS-CP**, **MT-HT**, **CH-OH** and **CY-CB**, each pair is shown with a coupling on the front panel of the Analog Rytm, share a voice. If both tracks of a coupled pair are played or triggered simultaneously, the right-hand track has a higher priority. Track **CP** will mute track **RS**, **HT** will mute **MT**, **OH** will mute **CH** and **CB** will mute **CY**. With sequencer recording deactivated, drum tracks may also be played using **[TRIG]** keys 1-12.

The color of the <PADS> will show pad activity. A pad will flash white briefly when engaged, whether it is played manually or by the Analog Rytm sequencer. The active drum track is shown with a red color pad.

8.2 MACHINES

Select a drum track MACHINE by quickly pressing the first **[PARAMETER]** key, **SYNTH**, twice. A MACHINE makes use of the physical percussion sound generator of the voice circuit in a certain way, in order to make a characteristic drum model.

For example, the **BD** track uses the sound generator of the first voice circuit. Its default BDHD MACHINE includes one tunable analog oscillator, a choice of three different waveforms and a custom envelope to shape the sound. These MACHINE-specific synthesis parameters are found on the SYNTH parameter page. Another MACHINE may be selected which will engage the sound generator in a different way - employing more than one oscillator, for example - enabling the **BD** track to perform frequency modulation and many other sound generating techniques.

All MACHINES can not be accessed from all tracks since the tracks control different physical sound generators. The illustration above shows the tracks that can make use of a specific type of percussion sound generator within the boundaries of the same gray-shaded box. For a more comprehensive list of MACHINES, the tracks that can use them and the specific SYNTH page parameters they give access to, please see "APPENDIX D: MACHINES" on page 89.

8.3 ROTARY ENCODERS

The eight **DATA ENTRY** knobs, the **LEVEL** knob, and the **MASTER VOLUME** knob are made of sturdy two-component plastic with a shape designed to fit snugly between thumb and forefinger, and a rubbery surface to prevent slipping. The **MASTER VOLUME** is an absolute encoder, spanning roughly 320 degrees from its left extreme to its right extreme. Its position is shown with a small white dot on its top surface. The **LEVEL** and **DATA ENTRY** knobs (with which you set various parameter values for the active kit), on the other hand, are relative encoders which may be spun any number of turns. Pressing and turning these encoders will change their associated values at a greater speed.

8.4 PRAGMATIC OPERATION

The functional layout of the Analog Rytm front panel ensures many complex operations can be done using only one hand, leaving the other hand free to tweak sounds. With all mode and track keys near each other, one-handed track muting, chromatic play, scene change and performance macro deployment is possible. As is one-handed retriggering, tempo tapping, pattern mode change, and pattern selection.

8.5 KEY BEHAVIOR

As a group, the track selection keys (**[TRACK]** + any of the **[PADS]** and the **[FX]** key) have radio button functionality, i.e. when a new track is set to be active, the previous one is simultaneously deactivated (one and only one track must always be selected). Likewise, the group consisting of the five **[PARAMETER]** keys and the **[TRIG SETUP]** key has radio button functionality.

The mode keys **[MUTE]**, **[CHROMATIC]**, **[SCENE]** and **[PERF]** keys have both on/off and radio button functionality (which means they may all be switched off, but only one of them may be on at the same time). This goes for the **[SONG MODE]** and **[CHAIN MODE]** keys as well.

The **[TRACK]**, **[FUNCTION]** and **[RETRIG]** keys must be pressed in combination with other keys to exert functionality.

8.6 MIDI NOTES

Some functions can be triggered by sending MIDI note values from an external MIDI device (a MIDI keyboard or a computer, for example) connected to the Analog Rytm via standard MIDI cable or a USB 2.0 A to B connector cable.

Of the 128 notes in the standard MIDI range, 0-11 corresponds to notes C0 through to B0, the leftmost octave (which is sometimes called C-2 - B-2 in certain applications) will trigger the Sound of track 1 through to track 12, respectively (provided they are set to their default channels 1-12). These note values map to each of the twelve tracks, regardless of which track is active.

MIDI note values 12-59 (corresponding to notes C1 - B4, the second through to the fifth octave in the MIDI range) will trigger the Sound of the active track in any of its 48 chromatic variations (as if played by the pads in CHROMATIC mode, see section below), from lowest to highest pitch. The track Sound needs to be chromatic enabled if any variation is to be heard. Activate via the SOUND SETTINGS found in "10.5 SOUND MENU" on page 31.

MIDI program change messages 0-127 will select pattern 1-128 (A01 - H16) on the Analog Rytm. Additionally, MIDI CC and NRPN messages can be sent to control various aspects of the Analog Rytm. See "APPENDIX C: MIDI" on page 79 for a complete specification.

8.7 MODE KEYS

There are four main keys with which you change the mode of operation on the Analog Rytm: **[MUTE]**, **[CHROMATIC]**, **[SCENE]** and **[PERF]**. The red LEDs above these keys show if the modes are active (full-bright) or inactive (off).

8.7.1 MUTE MODE

To activate the MUTE mode, press the **[MUTE]** key. To deactivate, press again. Mute any of the twelve drum tracks in this mode. Unlike the CHROMATIC mode, it makes no difference which track is active when this mode is on. All tracks are accessed simultaneously. Press any of the **[PADS]** to mute the corresponding track. Press again to unmute. The color of the <PADS> indicates the mute status. Unlit <PADS> are muted. Green <PADS> are audible.

Press and hold **[FUNCTION]** and then any of the **[PADS]** in order to preselect a mute, or mute/unmute several tracks in one go. Once you release **[FUNCTION]**, the selected mutes will come into effect. Preselected mutes are shown as <PADS> of sky blue color.

Press **[RETRIG]** and one of the **[PADS]** if you wish to activate solo, in other words, mute all tracks except the one selected. Press again to deactivate solo. Keeping **[RETRIG]** pressed, multiple tracks may be solo activated/deactivated. Solo activated <PADS> are turquoise.

The tracks you have muted in this mode stay muted even if the pattern is changed or a new kit is loaded. After exiting MUTE mode, the LED light atop the **[MUTE]** key will stay lit, half-bright red if any of the tracks are muted. The MUTE mode is a part of the active state of the machine. It is not stored to the current kit or pattern. Mutes activated in MUTE mode are the master mutes, and they will override any TRIG MUTE patterns on the sequencer or any SONG MUTE program on any pattern of the active song.

8.7.2 CHROMATIC MODE

Pressing the **[CHROMATIC]** key will turn the **[PADS]** of the Analog Rytm into a chromatic keyboard. Press again to deactivate. When in this mode, you will be able to play the Sound of the active track chromatically. To play another track Sound chromatically, change active track by pressing **[TRACK]** and one of the **[PADS]**.

Any track Sound may be played in this mode using the 12 pads. The chromatic note pitch is linearly increased for each successive pad pressed: left to right, bottom to top. Twelve pads in succession make up one octave. The range spans four octaves, middle, 1 up and 2 down. The middle octave has sky blue color <PADS>, the two below are of violet and dark blue color, in that order, and the one above is yellow. Reach higher or lower octaves, one row at a time, by pressing **[ARROW]** keys **[UP]** or **[DOWN]**, respectively.

The Synth part, the Sample part or both at once of any Sound may be chromatic enabled. This is done in the SOUND SETTINGS. See section "10.5 SOUND MENU" on page 31.

Notes triggered chromatically can be recorded on the sequencer. Find out how this is done in sections "11.3.2 GRID RECORDING MODE" on page 39 and "11.3.3 LIVE RECORDING MODE" on page 39.

Like the MUTE mode, the active state of the CHROMATIC mode (the portion of the chromatic keyboard currently visible on the pads) is not stored per kit or pattern but stays in the state to which it was set until it is changed.

8.7.3 SCENE MODE

The SCENE mode turns the twelve pads into instant sound shifters. Several parameters from any track can be changed by pressing a single pad. A scene is a fixed set of parameter values, ready to be activated or deactivated. To activate the SCENE mode, press the **[SCENE]** key. Press again to deactivate.

By carefully assigning a set of parameter values, you can prepare a scene that will make the same kit sound drastically (or subtly) different whenever activated. After exiting SCENE mode, the LED light atop the **[SCENE]** key will stay lit, half-bright red if any of the scenes are active. Unlike the MUTE or CHROMATIC mode, SCENE mode settings are stored to the active kit. See "10.3 SCENE MODE" on page 28.

8.7.4 PERFORMANCE MODE

Press the **[PERF]** key to enter PERFORMANCE mode. This mode enables the **[PADS]** to control several PARAMETER page parameters at once. Change many dimensions of one or more drum track Sounds at the touch of a single pad. A pad in this mode, prepared with one or many additive layers of parameter modulation, is called a performance macro. While setting up a performance macro is done in a similar way as setting up a scene, there is a major difference in the way these two modes operate. A scene is a static, ON/OFF command of an array of parameters set to specific values. A performance macro engages the assigned parameters in a dynamic way. When using a performance macro, the parameters will be modulated relative to the pressure applied to the pad.

8. ANALOG RYTM CONTROLS

To exit PERFORMANCE mode, press **[PERF]** key again. PERFORMANCE mode settings are stored as part of a kit. See “7.1.1 PERFORMANCE MODE” on page 19 to find out more about this mode.

9. PROJECTS

A project is the top level of the Analog RytM workflow. A project contains 128 patterns, 128 kits, 16 songs, 4 global slots, and a project Sound pool consisting of up to 128 Sounds. Projects are handy when, for example, you want to save a specific setup for a live performance or when managing a select number of compositions. The +Drive can store 128 projects.

When a project is loaded it becomes the active working state of Analog RytM, independent of the +Drive. Analog RytM will keep track of what project slot the active project was loaded from. When a project is loaded it is possible to edit its patterns, kits, songs, and globals.

Within an active project, all changes made are automatically remembered by the Analog RytM, letting you switch back and forth between patterns and kits and edit the patterns, kits and parameters in any order you like without the need to save each adjustment manually. Patterns, the active kit Sounds and settings, songs and globals are remembered even after the power is turned off. However, regarding kits (the main entity for editing and collectively storing a complete set of Sounds and effects), when the Analog RytM is switched off, only the settings of the active kit are preserved. If for example, the kit linked to pattern 1 is edited (kit A), another pattern is selected and its kit edited (kit B) and then the power is turned off, only the changes to kit B (the most recent active kit) will be remembered. We highly recommend that you specifically save the kits you have been working on manually using the quick command [YES/SAVE] + [FX]. Find out more about kits in the section "10. KITS AND SOUNDS" on page 27.

Project changes are not automatically written to the +Drive. To store the active working state of the project to a +Drive slot, the project needs to be saved manually. See below on how to load and save projects.

9.1 PROJECT MENU

Projects are managed in the PROJECT menu, located in the GLOBAL menu. Open the GLOBAL menu by pressing [FUNCTION] + [TRACK].



Scroll through the list by using [UP]/[DOWN] or the *LEVEL* knob and select PROJECT. Open the menu by pressing [YES/SAVE].



LOAD PROJECT opens a project selection screen where you choose a project to be loaded. Note that the active project will not be saved before loading the new project. This menu can be accessed directly by pressing and holding [FUNCTION] + [TRACK] for a little while. If you wish to create a new project, select **CREATE NEW** at the very bottom of the list. The new project will be a blank slate.



SAVE PROJECT AS opens a project selection screen where you choose a slot to save the active project to.



MANAGE PROJECTS launches the PROJECT MANAGER menu. Selecting a project in this menu and pressing the [RIGHT] arrow key will bring up a list of commands.



CLEAR resets the project slot to a clean state.

DELETE removes the project from the slot.

RENAME opens a screen where you can rename the project file.

LOAD FROM loads the selected project. This will overwrite the active project!

SAVE TO saves the active project to the selected slot.

TOGGLE toggles write protection on or off. Write protected projects can not be overwritten, renamed or erased. A write protected project is shown with a lock symbol.

INIT NEW initializes an empty file slot with a clean project. This operation is only available for empty project slots.

PURGE ALL purges (removes) all Sounds from the Sound pool and all samples that are not used in any pattern in the project from the RAM memory. The Sounds and samples are not removed from the +Drive Sound library. This option is only available when you select the currently loaded project.



- Multiple projects can be selected and deselected by highlighting them and pressing [YES/SAVE].
- The currently active project is linked to the slot shown with a small arrow in front of the project name.
- A lock symbol indicates the project is write protected.
- Projects can be copied/cleared/pasted.



LOAD FROM in the PROJECT MANAGER will overwrite the active project. Be sure to save your project before you load another.

10. KITS AND SOUNDS

Every project has the capacity of 128 different kits. A kit is a collection of 12 drum track Sounds and an FX track, and their specific parameter settings. A Sound is composed of synth, sample, filter, effect sends, envelope and LFO settings in any combination. Sounds are assigned to the twelve drum tracks.

Each of the drum tracks contains one Sound. The PARAMETER page settings for each track in a kit can be saved as an individual Sound, if so desired. A Sound that has been loaded, from the +Drive or the Sound Pool to a track, becomes a part of the active kit. Any changes made to a track Sound will not affect the stored Sound. It will affect and become part of the active kit. A pattern, controlling the playback of the kit, always links to a specific kit (non-exclusively). Any changes to the kit will affect other patterns using the same kit. When the Analog Rytm is switched off, only the active kit preserves its changes. Other kits must be saved.

A Kit contains:

- Sound parameter settings for the 12 drum tracks.
- FX track parameter settings.
- LEVEL settings for the drum and FX tracks.
- RETRIG settings.
- General SOUND SETTINGS.
- PERFORMANCE and SCENE mode macros and parameter settings.

A Sound contains:

- Settings for the PARAMETER pages of a drum track.



- The LCD graphics in the left part of the screen shows the name of the active kit. When the [TRACK] key and one of the [PADS] are pressed, this information will briefly change to show the name of the track Sound.
- When you create a brand new pattern, using an existing kit that is already linked to another pattern, we recommend that you save and rename the kit, the first thing you do (see below). Unless, of course, you intend kit changes to affect multiple patterns.

10.1 THE +DRIVE SOUND LIBRARY AND THE SOUND POOL

Sounds can be loaded to a kit from either the +Drive Sound library or the Sound pool of the active project. The +Drive Sound library has the capacity of 4096 Sounds, available to all projects. The Sound pool is a part of a project and can contain up to 128 Sounds. The major benefit of Sounds loaded to the Sound pool is the possibility for them to be Sound locked. This feature is not available for the Sounds in the +Drive Sound library. Read more about Sound locking in the section “11.10.2 SOUND LOCKS” on page 45.

10.2 KIT MENU

In the KIT menu commands relating to kits are found, including kit save and kit load. Open the menu by pressing [FUNCTION] + [FX]. Use the [UP] and [DOWN] arrow keys to move between the commands. Press [YES/SAVE] to confirm your selection. Exit the menu by pressing [NO/RELOAD].



RELOAD KIT will reload either the active kit, reverting it to its saved status or all kits. Using the [LEFT] and [RIGHT] keys selects whether only the active kit or all kits will be reloaded. [NO/RELOAD] + [KIT] offers a shortcut to reloading the active kit.

LOAD KIT opens a menu where one of the up to 128 saved kits can be loaded. When this menu is accessed, the kit list will appear. The active kit is shown with inverted graphics. Select the kit to be loaded by using the [ARROW] keys or the LEVEL knob. [LEFT]/[RIGHT] will quickly scroll between the menu pages. Once a kit has been selected, press [YES/SAVE] to load it. The loaded kit will be linked to the active pattern. If the active kit is loaded, it will be reloaded to the state it was saved in. Kits that are not associated with any pattern are distinguished by a star symbol after the kit name.

01 BRENDA	05 PUSH ME
02 DODECHA	06 IO
03 NO SLEEP	07 RHYTHICON
04 SOL	08 CICADA



SAVE KIT saves all the current kit related settings as a kit. When a kit is saved, it will be linked to the active pattern. **[YES/SAVE] + [FX]** offers a shortcut to this command, saving the kit instantly to the same slot and with the name of the kit unchanged. It is good practice to use the shortcut frequently to ensure kit changes are saved.

When this menu is opened, the kit list will appear. The active kit is shown with inverted graphics. Select the slot to which the kit will be saved by using the **[ARROW]** keys or the **LEVEL** knob. Press **[YES/SAVE]** to save to the selected slot. The **NAMING** screen, covered on page 17, will appear.

CLEAR KIT will clear the content of the currently loaded kit, basically initializing it. When selecting this option a prompt will appear. Press **[YES/SAVE]** to clear the kit or **[NO/RELOAD]** to cancel the operation. Note that no kit information will be permanently lost until the kit is saved to the same kit slot it was loaded from.

TRACK ROUTING highlight this item, found at the very bottom position of the **KIT** menu, and press **[YES/SAVE]** to customize track routing. The default setting is to use the **TRACK ROUTING** global settings found in the **GLOBAL** menu. See section "13. GLOBAL MENU" on page 53.

If you want custom settings for the currently active kit, press **[YES/SAVE]** to untick the **USE GLOBAL SETTING** box and to open the complete **ROUTING** menu. Use **[ARROW]** keys **[UP]** and **[DOWN]** to highlight one of the three options.



USE GLOBAL SETTING press **[YES/SAVE]** if you decide to use **GLOBAL** settings after all. The **<PADS>** will show what the current **GLOBAL** settings are for the drum tracks. **<PADS>** of a green color send to main. Unlit **<PADS>** do not.

ROUTE TO MAIN highlight this option to customize which of the 12 tracks will send to the master effects (Distortion and Compressor) and main output. Use the **[PADS]** to activate/deactivate send from the track of each corresponding pad. **<PADS>** of a green color send to main. Unlit **<PADS>** do not. Note that each track will still send to its individual output.

ROUTE TO FX highlight this option to customize the send **FX** routing of the 12 tracks. Use the **[PADS]** to activate/deactivate each corresponding track for sending to the send **FX** (Delay and Reverb). **<PADS>** of a yellow color send to **FX**. Unlit **<PADS>** do not.



- Copy, clear and paste operations are available in the **LOAD KIT** and **SAVE KIT** menus.
- Use the **LEVEL** knob to scroll through the **LOAD KIT** and **SAVE KIT** menus.
- Once you have assembled a kit you like or changed it in a desirable fashion, don't forget to save it using the shortcut **[YES/SAVE] + [FX]**.
- A kit that is not used by any pattern is shown with an asterisk symbol following the kit name.

10.3 SCENE MODE

Press **[SCENE]** to enter scene mode. A scene is a collection of fixed parameter locks. It enables an instant makeover of how the tracks of the active kit will sound, at the touch of a single pad. 12 scenes may be assigned, one for each of the **[PADS]**.

Press one of the **[PADS]** when in scene mode to activate a scene. Only one scene may be active at a time. When active, the pad to which the scene is assigned will glow blue. The **<PADS>** of non-empty, inactive scenes glow half-bright blue. Empty scenes have unlit pads. If the pad of the active track contains a scene, the pad will exhibit violet color (a mix of the active track color and the scene color, red and blue).

10.3.1 SCENE EDIT

There are 12 assignable scenes available, one for each pad. Make sure **SCENE** mode is active. Select

which scene to edit by pressing one of the [PADS]. Then press and hold the [SCENE] key for a short while to edit the scene.



When SCENE mode is active, [FUNCTION] + one of the [PADS] offers a convenient short-cut to scene edit mode.

When scene edit is active, the LCD screen left-hand side will reveal a list showing, from the top, the scene number, the number of locked parameters, an option to clear the scene and an option to clear all scenes. Use the [ARROW] keys [UP] and [DOWN] to navigate this list.

```

SCENE 1  TUN  SHT  HLD  DEC
LOCKS 8   [G]  [G]  [G]  [G]
<CLEAR>  SNP  HAV  ATK  LEV
<CLEAR ALL> [G]  [G]  [G]  [G]
  
```

SCENE shows which scene is being edited. Use [ARROW] keys [LEFT] and [RIGHT] to select another scene.

LOCKS shows the number of parameter locks assigned to the scene. This figure will only change by adding or removing parameter locks (see below).

<CLEAR> clears all parameter locks assigned to the scene being edited. Press [YES/SAVE] when this option is highlighted to clear the scene.

<CLEAR ALL> clears all parameter locks on all the 12 scenes. Press [YES/SAVE] when this option is highlighted to clear all scenes.

While keeping the scene pad pressed, various parameters can be locked to the scene by turning the **DATA ENTRY** knobs. Any parameter, from any of the 13 tracks, can be modulated and locked to the scene. Choose the drum tracks from which the parameter locks will be assigned by pressing [TRACK] + [PADS]. If parameters from the FX track are to be locked to the scene, press the [FX] key. The parameters available for modulation and scene assignment will be visible on the LCD screen.

When a scene is edited, the pads of drum tracks containing parameter locks will glow half-bright red and flicker. The active track, from which parameter locks are currently set, will glow full-bright red. If a scene contains FX track parameter locks, the FX track red LED will flicker while editing the scene. When the scene pad is pressed during edit, parameter locks are shown with inverted graphics and their fixed values (provided the particular track, and the particular parameter page where the locked parameter is located, is active) are also shown.

A total of 48 different parameters may be locked to any of the 12 scenes, in any combination, for each kit. For example, 48 parameter locks may be used for a single scene, two scenes may use 24 parameter locks each, four scenes may use, say, 2, 4, 10 and 32 parameter locks, and so on.

The scene of each pad can be copied, pasted to another pad or cleared using [FUNCTION] + [RECORD]/[STOP]/[PLAY], respectively. SCENE settings are stored to the active kit. Remember to save the kit regularly with [YES/SAVE] + [FX].

Once the editing is done, simply press the [SCENE] key again to exit scene edit mode. The parameter locks you entered will be instantly enabled whenever the scene is activated.



Use a scene if you want to affect the overall impact - overt or subtle - of your kit in a snap. Create the impression, for example, that your studio drum kit all of a sudden is played in a near vacuum, shattered by distortion or subject to NY compression (or all three at once) - then back to normal again.

10.4 PERFORMANCE MODE

Enter PERFORMANCE mode by pressing the [PERF] key. The PERFORMANCE mode enables you to tweak one or several parameters, chosen from any track, by applying different amounts of pressure to any of the [PADS] containing a performance macro.



By gently increasing the amount of pressure applied to a pad containing a performance macro (or quickly pressing, and then gently releasing the applied pressure), all intermediate values of the parameter lock range can be heard while going from one extreme of the modulation depth to the other.

10.4.1 PERFORMANCE EDIT

Make sure PERFORMANCE mode is active. Press and hold the [PERF] key for a short while to enter edit mode.



When PERFORMANCE mode is active, [FUNCTION] + one of the [PADS] offers a convenient shortcut to scene edit mode.

There are 12 assignable performance macros available, one for each pad. Select which macro to edit by pressing one of the [PADS]. When performance edit is active, the LCD screen left-hand side will reveal a list showing, from the top, the performance macro number, the number of locked parameters, an option to clear the macro and an option to clear all macros. Use the [ARROW] keys [UP] and [DOWN] to navigate through this list.

```

PERF 1  TUN  SHT  SWD  DEC
LOGKS 1  +24  [ ]  [ ]  [ ]
<CLEAR>  WRV  HLD  TRA  LEV
<CLEAR ALL> [ ]  [ ]  G1  [ ]

```

PERF shows which performance macro is being edited. Use [ARROW] keys [LEFT] and [RIGHT] to select another performance macro to edit.

LOGKS shows the number of parameter locks assigned to the performance macro. This figure will only change by adding or removing parameter locks (see below).

<CLEAR> clears all parameter locks assigned to the performance macro being edited. Press [YES/SAVE] when this option is highlighted to clear the macro.

<CLEAR ALL> clears all parameter locks on all the 12 performance macros. Press [YES/SAVE] when this option is highlighted to clear all macros.

While keeping the pad pressed, various parameters can be locked to the macro by turning the **DATA ENTRY** knobs. Any parameter, from any of the 13 tracks, can be locked to the macro. Choose the drum tracks from which the parameter locks will be assigned by pressing [TRACK] + [PADS]. If parameters from the FX track are to be locked to the macro, press the [FX] key. The parameters available for modulation and macro assignment will be visible on the LCD screen.

When a macro is edited, the pads of drum tracks containing parameter locks will glow half-bright red and flicker. The active track, from which parameter locks are currently set, will glow full-bright red and flicker. If a macro contains FX track parameter locks, the FX track red LED will flicker while editing. When a pad containing a performance macro is pressed during edit, parameter locks are shown with inverted graphics and their modulation depth values (provided the particular track, and the particular parameter page where the locked parameter is located, is active) are also shown.

A total of 48 different parameters may be locked to any of the 12 performance macros, in any combination, for each kit. For example, 48 parameter locks may be used for a single macro, two macros may use 24 parameter locks each, four macros may use, say, 2, 4, 10 and 32 parameter locks, and so on.



- While the process of editing a performance macro is similar to editing a scene, the parameter locks have a completely different functionality. Whereas scene mode locks are fixed values, performance mode locks are modulation depth settings.
- If, for example, the TUN parameter on the SYNTH parameter page of the BD track is locked to a value of +24, the performance macro will, when engaged, perform a relative increase of the TUN setting of the track Sound between 0 and +24, depending on the amount of pressure applied to the pad to which the performance macro is assigned. 0 if no pressure is applied, 12 if medium pressure is applied and 24 if maximum pressure is applied.
- If the TUN parameter is locked to a value of -24 instead, no pressure will produce a relative value decrease of 0, medium pressure -12 and maximum pressure -24.
- Note that the offset is relative to the general TUN (or any other) parameter setting: if the general setting is 30, a parameter lock with a modulation depth of +24 is set and maximum pressure is applied to the pad which contains the performance macro, the resulting value will be +54.

The macro of each pad can be copied, pasted to another pad or cleared using [FUNCTION] + [RECORD]/[STOP]/[PLAY], respectively. PERFORMANCE mode settings are stored to the active kit.

Remember to save the kit regularly with [YES/SAVE] + [FX].

Once the editing is done, simply press the [PERF] key again to exit edit mode. The parameter locks you entered will be activated whenever the pad containing the performance macro is pressed, provided PERFORMANCE mode (but not performance edit) is active. The relative modulation depth of all locked parameters will respond to the amount of pressure applied to the pad.



As the name implies, the **PERFORMANCE** mode is a live performance feature. As is the **SCENE** mode. When recording on the sequencer, **PERFORMANCE** mode macros and **SCENES** are not possible to parameter lock.

10.5 SOUND MENU

In this menu Sounds in the +Drive Sound library or in the Sound pool of the active project can be browsed and managed. Other menu options let you clear the track Sound, rename the track Sound or change the settings for the track Sound. Open the menu by pressing [FUNCTION] + [MUTE]. Use the [UP] and [DOWN] arrow keys to move between the options. Press [YES/SAVE] to confirm your selection. Exit the menu by pressing [NO/RELOAD].

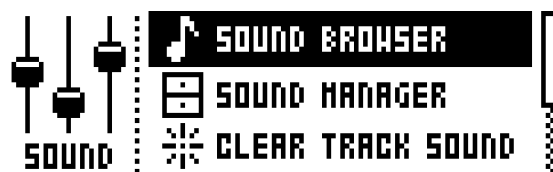

10.5.1 SOUND BROWSER

The **SOUND BROWSER** is for previewing and loading of Sounds. Opening the menu will show a list of all Sounds in either the +Drive Sound library or the Sound pool. Only the Sounds that can be loaded to the active track will be shown. For example, if the CH track is active, only the Sounds using the MACHINES available for the CH (and OH) track will be visible. If you wish to browse various Bass Drum Sounds, for instance, first make sure the **BD** is the active track by pressing [TRACK] + the first [PADS] key. Scroll the list by turning the **LEVEL** knob or by pressing [UP]/[DOWN]. Load a Sound by pressing [YES/SAVE]. Unlike the **SOUND MANAGER** menu, it does not have the **SOUND OPERATIONS** menu. Also, empty Sound slots are not shown here.



Pressing [LEFT] will access the **SORTING** menu. Press [YES/SAVE] to execute the commands. Press [NO/RELOAD] or the [RIGHT] arrow key to exit the menu.



POOL lists Sounds available in the Sound pool of the active project. The command is only available when browsing the +Drive Sound library.

+DRIVE lists Sounds available on the +Drive Sound library. The command is only available when browsing the Sound pool of the active project.

SORT ABC sorts the Sounds in alphabetical order. The command is only available when Sounds are being sorted by slot number.

SORT 123 sorts the Sounds by slot number (or +Drive position). The command is only available when Sounds are being sorted alphabetically.

FILTER opens a list where Sounds can be arranged according to tags. Select and deselect tags by pressing [YES/SAVE]. Multiple tags can be selected. Exit the tag list by pressing [NO/RELOAD].

SEARCH will perform a text search and list all Sounds with names matching or including the text input. See “6.5 THE NAMING SCREEN” on page 17 on how to enter text.

10.5.2 SOUND MANAGER

The SOUND MANAGER is a more comprehensive version of the SOUND BROWSER. Sounds can be saved, loaded, renamed, tagged et cetera. Opening this menu will show a list of all Sounds found in either the +Drive Sound library or the Sound pool. Unlike the browser, all Sounds will be shown, not just the Sounds that can be used by the active track. The color of the active track pad will show if the Sound can be loaded or not. Violet color means it can. Additionally, when a Sound is highlighted, the <PADS> of all tracks to which the Sound can be loaded will be shown in dim red color. Sounds can be previewed by tapping the pad of the active track, provided that the Sound can be voiced by the track (i.e. the pad color is violet) Scroll the list by turning the *LEVEL* knob or by pressing [UP]/[DOWN].



Pressing [LEFT] will access the SORTING menu. The available commands are the same as those found in the SORTING menu of the SOUND BROWSER. Read more in the section “10.5.1 SOUND BROWSER” on page 31.

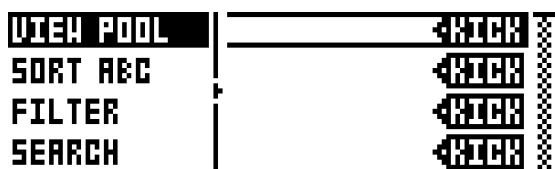

Pressing [RIGHT] will access the SOUND OPERATIONS menu. The available operations will affect the highlighted Sound. Press [YES/SAVE] to apply the commands to the selected Sound. Press [NO/RELOAD] or the [LEFT] arrow key to exit the menu.

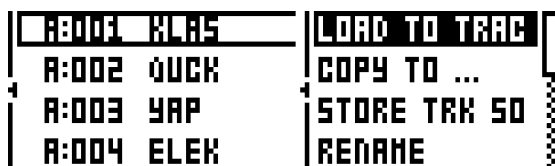

LOAD TO TRACK loads the selected Sound to the active track and makes it a part of the active kit.

COPY TO... Copies the selected sounds to one of the following:

- POOL copies the selected Sounds to the first free slots of the active project Sound pool.
- +DRIVE copies the selected Sounds to the first free slots of the +Drive Sound library.
- +BANK (A-P) copies the selected Sounds to the first free slots of a specific bank inside the +Drive.

STORE TRACK SOUND saves the active track Sound to the selected slot. Please note that outside of the SOUND MANAGER, at any time (except when in MUTE mode or SONG EDIT mode), [YES/SAVE] + [MUTE] offers a shortcut to this operation.

RENAME will rename the selected Sound.

EDIT TAGS opens a menu where Sounds can be tagged. Sounds can have any number of tags, but only the first two will be shown on the Sound list. Apply or remove tags by pressing [YES/SAVE].

DELETE will delete the Sound.

SELECT ALL selects all Sounds in the list.

SELECT UNUSE selects all Sounds that are not used in any pattern in the project from the Sound pool. The Sounds are not removed from the +Drive Sound library. Then select DELETE to remove the selected sounds from the project’s Sound pool. The SELECT UNUSED command is only available when you browse the Sound pool of the active project.

DESELECT ALL deselects all Sounds in the list.

TOGGLE will enable or disable write protection for the selected Sounds. When a Sound is write protected it cannot be overwritten, renamed, tagged or deleted.

SEND SYSEX sends the selected Sounds as SysEx data.



- Sounds in the +Drive Sound library are organized into 16 banks, ranging from A to P. Each bank can contain 256 Sounds. Use the [TRIG] keys to view only Sounds located in a specific bank.
- You can preview the currently selected Sound by tapping the pad of the active track. All Sounds available for the active track can be previewed. Please note that if the previewed Sound is sent to the effects, the current effects settings will affect it.
- Several Sounds can be simultaneously affected by the commands available in the SOUND OPERATIONS menu. Select/deselect individual Sounds by highlighting them and pressing [YES/SAVE].
- Press [FUNCTION] + [UP]/[DOWN] for faster scrolling in the Sound list.

CLEAR TRACK SOUND will set the PARAMETER page parameters of the active track to their default values. When choosing this option a prompt will appear. Press [YES/SAVE] to reinitialize the parameters or [NO/RELOAD] to cancel the operation. Note that no parameter information will be permanently lost until the kit is saved to the same slot it was loaded from.

RENAME TRACK SOUND opens a NAMING screen where the Sound of the active track can be renamed.

SOUND SETTINGS opens a menu where various overarching Sound settings are found. These settings are stored to the active kit. Use the [UP]/[DOWN] arrow keys or the LEVEL knob to scroll through the menu. Use the [LEFT]/[RIGHT] arrow keys to change the settings.



MACHINE select the MACHINE with which the active track Sound will be generated. Only the MACHINES available for the active track will be shown. To swiftly change MACHINE, use the short-cut command by quickly pressing the first [PARAMETER] key, SYNTH, twice. To find out more about MACHINES, see “APPENDIX D: MACHINES” on page 89.

CHROMATIC sets which parts of the Sound CHROMATIC mode, as well as the trig page NOT parameter, will affect:

- OFF means the pitch will not be affected at all.
- SYNTH affects the pitch of the Synth part only.
- SAMPLE affects the pitch of the Sample part only.
- SYN+SMP affects the pitch of both Synth and Sample parts.

ENV RESET sets the filter envelope behavior:

- OFF does not reset the envelopes for each consecutive trig (lets the cycle complete).
- FILT resets the envelopes for each consecutive trig (default).

VELOCITY TO VOL select how velocity will affect volume when playing the Sound on the [PADS] or with an external MIDI unit.

- OFF means velocity will not affect the volume of the Sound.
- ON means the volume will correspond linearly to velocity.

VELOCITY MOD gives access to a menu where up to four PARAMETER page parameters can be assigned to the velocity mod parameter. Open the menu by pressing [YES/SAVE]. Use **DATA ENTRY** knobs A-D to select parameters from any of the PARAMETER pages. Use **DATA ENTRY** knobs E-H to set the modulation depth for the chosen parameters. Use the **LEVEL** knob to set the overarching velocity range.

AFTERTOUCH gives access to a menu where up to four **PARAMETER** page parameters can be assigned to the **[PADS]** or external MIDI unit aftertouch command. Open the menu by pressing **[YES/SAVE]**. Use **DATA ENTRY** knobs **A-D** to select parameters from any of the **PARAMETER** pages. Use **DATA ENTRY** knobs **E-H** to set the modulation depth for the chosen parameters. Use the **LEVEL** knob to set the overarching velocity range.



- Copy, clear and paste operations are available in the **SOUND BROWSER** and **SOUND MANAGER**.
- Use the **LEVEL** knob to increase scrolling speed in the **SOUND BROWSER** and **SOUND MANAGER**.

10.6 PLAYING A SOUND

Play the drum track Sounds of the active kit by tapping any of the twelve **[PADS]**. <PADS> will briefly flash when tapped. Each pad is velocity sensitive, which means a gentle tap and a decisive stab on the pad will produce drum sounds of different intensities.

Use **[FUNCTION]** + **[PADS]** to trig the Sound at the velocity set on the trig page for each track (the **VEL** parameter).

The **[TRIG]** keys 1-12 can also be used to play the Sounds of the twelve tracks, also at the velocity set on the trig page for each track.

Press and hold **[RETRIG]**, then press and hold any of the **[PADS]** to continuously retrigger the track Sound for as long as the pad is held. Play drum rolls in this manner on one or several of the pads, each with its own assignable retrigger settings. Pressure controls retrigger velocity. Aftertouch is disabled during retrigger. See “11.4 RETRIG MENU” on page 40.

Sounds that are designed for aftertouch play may be played by tapping and then pressing a pad without lifting your finger in between. Settings controlling this can be found in the **SOUND** menu. See “10.5 SOUND MENU” on page 31.

PLAYING A SOUND WITH AN EXTERNAL MIDI UNIT

Besides using the **[PADS]**, the Sounds can also be played using an external MIDI unit connected to Analog Rytm. Which MIDI tracks the voices respond to are set up in the **MIDI CHANNELS** menu, covered in the section “13.4.3 CHANNELS” on page 57.

10.7 EDITING A SOUND

Activate one of the drum tracks for editing by pressing **[TRACK]** + one of the **[PADS]**. The information bar on the LCD screen, showing which kit is loaded, will briefly change to show the name of the drum track Sound. When editing, the **MACHINE**, Sound and sample settings of the track can be changed, and any changes made will be stored as part of the active kit.

Adjust the overall volume level of the active drum track with the **LEVEL** knob.

The current **MACHINE** in use will determine which **SYNTH** parameters will be available for Sound modulation. Quickly press the first **[PARAMETER]** key, **SYNTH**, twice to open a menu for **MACHINE** selection.



Browse through the **MACHINE** list using the **[ARROW]** keys **[UP]** and **[DOWN]**. Sample the **MACHINE** currently outlined by tapping the pad of the active track. Select the outlined **MACHINE** by pressing **[YES/SAVE]**. Exit without switching **MACHINE** by pressing **[NO/RELOAD]**.

Edit a track Sound by adjusting the parameters found on the **PARAMETER** pages. Access these pages by pressing one of the five **[PARAMETER]** page keys. Use the **DATA ENTRY** knobs **A-H** to change the parameters. For a complete description of the functions of the parameters, please see “APPENDIX A: DRUM TRACK PARAMETERS” on page 72.

SYNTH controls the analog drum synthesis parameters of the **MACHINE** selected.

SAMPLE controls the sample selection and settings.

FILTER controls the filter mode, cutoff frequency, and envelope.

AMP controls the amplitude parameters, effect sends, and levels.

LFO controls parameters for the LFO of the active track.

When you want to save a particular Sound with all its current parameter settings, use the quick command **[YES/SAVE] + [MUTE]**. Toggle destination, Sound Pool or +Drive, by accessing the left-hand menu, **[ARROW]** key **[LEFT]**, then press **[YES/SAVE]**. Select which slot to save to using the **[ARROW]** keys **[UP]** and **[DOWN]**, or the LEVEL knob, and press **[YES/SAVE]**. If you select a non-empty slot, the current Sound will overwrite the Sound previously saved to the slot. Name the Sound (see “THE NAMING SCREEN” on page 10) and select a suitable tag, or several tags (KICK, SNARE, RIMSHOT et cetera), using the **[ARROW]** keys + **[YES/SAVE]**.

The complete Sound, comprised of all its parameter settings, may be copied to another track by first pressing **[TRACK] + [RECORD]**, then selecting the track you want to copy the Sound to using **[TRACK] +** one of the **[PADS]**, and finally pasting by pressing **[TRACK] + [STOP]**. Note that the Sound can only be pasted to a track that is compatible with the Sound (see illustration on page 21).

10.8 SELECTING A SAMPLE

Any of the 127 user samples may be assigned to a Sound on any of the drum tracks. The user samples can be replaced, relocated and otherwise managed in the SAMPLES manager found in the GLOBAL MENU. See section “13. GLOBAL MENU” on page 53. Select the active drum track by pressing **[TRACK] +** one of the **[PADS]**. Open the SAMPLE parameter page by pressing the second **[PARAMETER]** key, **SAMPLE**.

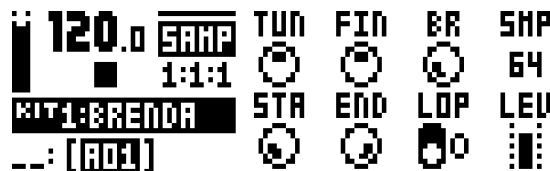

Press **DATA ENTRY** knob **D** to bring up a list of samples.



Turn the knob counter-clockwise to scroll up the list, clockwise to scroll down the list. Tap the pad of the active track while browsing to listen to the sample currently outlined.

Press **[FUNCTION]** and **[YES/SAVE]** to replace a sample in one of the slots with one found in any of the sample directories. To learn more about sample directories, see “GLOBAL MENU” on page 51.

To select an outlined sample, press **[YES/SAVE]**. Press **DATA ENTRY** knob **D** or **[NO/RELOAD]** to exit the list without selecting a sample.



Sample selection may also be accessed by quickly pressing the second **[PARAMETER]** key, **SAMPLE**, twice.

10.9 EDITING THE FX

Select the FX track for editing by pressing the **[FX]** key. The FX track controls Analog Rytm internal send effects (Delay and Reverb) and master effects (Distortion and Compression). Editing the FX track is similar to editing the Sounds of the drum tracks. The **PARAMETER** pages contain all FX parameters.

There are five **PARAMETER** pages for the FX track. Access the **PARAMETER** pages by pressing one of the **[PARAMETER]** keys. Use the **DATA ENTRY** knobs **A-H** to change the parameters. The first two, Delay and Reverb, are send effects: their parameters are set on the FX track, but their incoming signals are set on the DEL and REV send parameters on the AMP page of each individual drum track. The following two, Distortion and Compressor, are master effects: they condition all sounds with distortion or compression. The last page is the dedicated FX track LFO, with which you can temper any of the parameters on the FX track with a custom low-frequency oscillation along one of seven possible waveforms, enabling - to name but one example - tidal modulation of sound distortion. For complete explanations of the parameters on the FX track, please see “APPENDIX B: FX TRACK PARAMETERS” on page 75.

DELAY controls the character, reverb send and volume of the delay send effect.

REVERB controls the character and volume of the reverb send effect.

DISTORTION controls the amount and character of distortion applied.

COMPRESSOR controls the behavior, volume and dry/wet mix of sound compression.

LFO controls parameters for the FX track LFO.



- **FX and track parameter settings are stored as part of a kit. Don't forget to save the kit and give it a unique name once you have achieved the results you want, or simply press [YES/SAVE] + [FX] to quickly save the active kit with its name unchanged.**
- **You are advised not to use the effects too liberally when shaping a basic Sound. Rather, add FX to taste at choice parts of the composition: triggered on and off as part of a pre-programmed sequencer pattern or as SCENE and PERFORMANCE macros ready to be unleashed live.**

Set the master return level of the Delay and Reverb outputs on the FX track with the LEVEL knob. These send effects also have individual volume parameters.

11. THE SEQUENCER

The sequencer of the Analog Rytm MKI stores beat information in patterns. A pattern controls the playback of the drum tracks, the FX track and various pattern-specific aspects of these. Each of the 8 banks, ranging from A to H, contains 16 patterns, which means 128 patterns are instantly available for each project. All changes made to the patterns are stored automatically. Changes made to the active pattern can be reverted, as long as it is active. Read more in the “PATTERN MENU” on page 38.



All sequencer tracks on the Analog Rytm MKI can also be set to send sequencer data through the MIDI OUT or USB ports to control external, MIDI equipped, gear. Each track sends note on/off and velocity data over MIDI. For more information, please see “11.7.1 TRIGS SETUP MENU” on page 43.

A pattern contains:

- General trig settings on the TRIG page (default note pitch, velocity et cetera).
- Quantization settings.
- Note trigs for all tracks.
- Trigless locks for all tracks.
- Parameter locks.
- Sound locks.
- Trig mutes.
- Accent trigs.
- Slide trigs.
- Swing trigs & swing amount.
- A kit linked to the pattern.
- Length and time signature for the tracks.

11.1 BASIC PATTERN OPERATIONS

Analog Rytm MKI can seamlessly switch between patterns. This, along with the ability to chain patterns, is a handy feature when improvising live.

11.1.1 SELECTING A PATTERN

Press the [BANK GROUP] key to choose the bank group from which a pattern will be selected. If for example bank group A-D is chosen, patterns in banks A, B, C and D can be selected. Next, press a [BANK] key followed by a [TRIG] key to select a pattern within the selected bank. To select pattern B05, choose bank group A-D using the [BANK GROUP] key. Then press [BANK B/F] and [TRIG] key 5.

Patterns containing data are shown with half-bright red <TRIG> LEDs. The current active pattern is shown with a full-bright red <TRIG> LED.

When you select a pattern containing no data, the kit of the previous pattern will be preliminarily selected, and the kit number will start flashing on the LCD screen (to draw attention to the fact that the kit is not yet decisively linked to the new pattern). Load another kit, if you wish, at this point. When you start editing the pattern, or save the kit, the kit will be linked to the pattern, and the kit number will stop flashing on the LCD screen.

When a pattern is playing and a new pattern is selected, the new pattern position will be shown flashing in the lower left corner of the LCD screen (if default, SEQUENTIAL, pattern mode is active). Once the last step of the pattern has played, the new pattern will start and the pattern position will cease to flash.



- Pattern selection can be made using only one hand. After a [BANK] key has been pressed, a window will appear for a short while, stating “CHOOSE PTN.” If a [TRIG] key is pressed while this window is visible, a pattern will be selected.
- Patterns can be changed while the sequencer is running.
- Patterns can be changed and queued by sending program change messages.
- After a pattern is selected, and before releasing any key, [REC], [PLAY] and [STOP] can be pressed to copy, clear or paste patterns without leaving the active pattern. It is possible to clear and paste multiple patterns at the same time.

11.1.2 PATTERN CONTROL

Pressing [PLAY] will start the playback of a pattern. Pressing [STOP] will stop the playback of all tracks. The sound will be cut off, but effects like Delay will continue to be audible until the delay repeats have

faded out. When the sequencer has stopped, quickly press [STOP] + [STOP] to stop playback of all tracks and fade out the send effects. This also sends out an All Sound Off message over MIDI.

When a pattern is playing and [PLAY] is pressed the playback will be paused. Press [PLAY] again to resume the playback.

If a pattern contains more than 16 sequencer steps, the <PATTERN PAGE> LEDs will indicate this. When a pattern is playing, the currently active pattern page is shown with a flashing, full-bright, <PATTERN PAGE> LED.

11.1.3 TEMPO

Press the [TEMPO] to open the TEMPO screen where you can set the overall BPM speed.



Use the **LEVEL** knob to change the tempo setting. The [UP] and [DOWN] key changes the decimal part of the tempo.



Note that you can choose between a project tempo (same tempo for all the patterns in a project) or use a separate tempo for every pattern. Press [FUNCTION] + [YES] to switch between PROJECT and PATTERN tempo mode.

To tap a tempo setting, hold the [FUNCTION] key and tap the [TEMPO] key in a steady rhythm. After four consecutive taps, the average tempo of the taps will be calculated. By continuing tapping, the average tempo will keep on updating.

The tempo can be temporarily nudged up or down by 10% by pressing the [LEFT] or [RIGHT] arrow keys. When the key is released, the BPM will revert to the original setting.

When in the TEMPO menu, holding [FUNCTION] while turning the **LEVEL** knob will not change the tempo to the selected value until the [FUNCTION] key is released. While doing this, "PREP." will flash in the bottom left corner of the screen.



Tempo shift is very handy when manually syncing Analog Rytm to a turntable or an external sound source. Note that you do not need to be in the TEMPO menu to perform tempo shifting

11.2 PATTERN MODES

When changing patterns, different modes affecting the way the active pattern will be changed exist. Toggle between the PATTERN modes by pressing [FUNCTION] + [BANK GROUP]. The <PATTERN MODE> LED shows which mode is selected. Three PATTERN modes exist.

DIRECT START will immediately change patterns. The new pattern will start playing from the beginning. This mode is shown with a red <PATTERN MODE> LED.

DIRECT JUMP will immediately change patterns. The new pattern will start playing from the position where the previous pattern left off. This mode is shown with a green <PATTERN MODE> LED.

SEQUENTIAL will change patterns after the pattern currently playing reaches its end. This mode is the default mode. It is shown with an unlit <PATTERN MODE> LED.

11.3 EDITING A PATTERN

Analog Rytm offers three modes of input when editing or creating a pattern, GRID RECORDING mode, LIVE RECORDING mode, and STEP RECORDING mode.. In these modes, two types of trigs can be entered: note trigs and trigless locks.

11.3.1 TRIG TYPES

Two types of trigs exist, note trigs and trigless locks. Note trigs trig notes while trigless locks can be used to apply parameter locks without triggering notes. Setting SYN and SMP (see "TRIG MENU" on page 38) to zero on a trig will turn it into a trigless lock. Note trigs are shown with full-bright <TRIG> LEDs and trigless locks are shown with half-bright blinking <TRIG> LEDs. A trig that contains both a note trig and a trigless lock is shown with a full-bright blinking <TRIG> LED. <TRIG> LEDs above steps not containing

any trigs remain unlit. Read more about parameter locks in section “11.10.1 PARAMETER LOCKS” on page 45. The two types of trigs are entered differently depending on whether GRID or LIVE recording mode is active.

11.3.2 GRID RECORDING MODE

GRID RECORDING is a method of composing where trigs are added by using the [TRIG] keys.

Enter GRID RECORDING mode by pressing the [REC] key. A lit red <REC> LED indicates GRID RECORDING mode is active. Select the track to which you want to add trigs, the active track, by pressing the [TRACK] key + one of the [PADS]. Place note trigs on the sequencer by pressing the [TRIG] keys 1-16 in the sequence desired. When CHROMATIC mode is active, the pitch value of the note trig will be recorded according to which [PADS] key is pressed. To add a trigless lock, press [FUNCTION] and [TRIG]. Add micro timing to a note trig by pressing and holding the [TRIG] key while pressing [ARROW] keys [LEFT] or [RIGHT]. A micro timing pop-up menu will appear, showing the time offset.

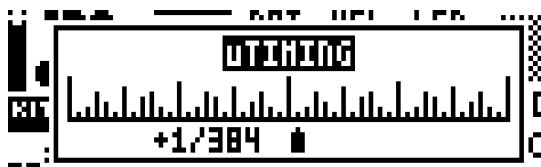

Set the retrig speed by pressing and holding the [TRIG] key while pressing [ARROW] keys [UP] or [DOWN]. Similarly, a pop-up menu will appear on the screen, where various retrig settings can be made. Read more about the retrig menu on page 36.

If the pattern contains more than 16 steps, select the pattern page you want to edit by pressing the [PAGE] key. The active pattern page is shown with a fully lit <PATTERN PAGE> LED.

Press [PLAY] to listen to the sequence.



- Press [TRIG] + [YES] to preview a specific trig. The preview includes any parameter locks you have placed on that trig.
- All trigs of a track can be shifted forwards or backward on the sequencer. While in GRID RECORDING mode, hold down [FUNCTION] while pressing the [LEFT] or [RIGHT] arrow keys to perform the trig shift.

11.3.3 LIVE RECORDING MODE

LIVE RECORDING mode is the second method of adding trigs to the tracks. In this recording mode, the [PADS] are played in real time to input trigs to the tracks. It is also possible to enter parameter locks in real time. Trigs input in LIVE RECORDING mode will be placed on the sequencer in a micro-timed fashion, which means the μ TM parameter in the TRIG SETUP menu will be locked accordingly to more accurately reflect the input timing of the trigs. This makes LIVE RECORDING mode record note inputs in a more expressive and non-quantized way. Micro timed trigs can be quantized, which is done in the TRIG SETUP menu accessed by pressing [FUNCTION] + [TRIG SETUP]. Quantizing is covered on page 39.

Hold [RECORD] and press [PLAY] to enter LIVE RECORDING mode. The sequencer will start to play and the <RECORD> LED will start to flash. You can now enter trigs to the active track in real time by playing the [PADS]. Key presses on the [PADS] will be recorded as note trigs, and the velocity and duration of the key presses will affect the values of the note trigs. Also, the pitch value of the note trig, if CHROMATIC mode is active, will be recorded. Any changes to the PARAMETER page settings, using the **DATA ENTRY** knobs, will be recorded on the sequencer as parameter locks.

In order to activate or deactivate quantization of the LIVE RECORDING, press [RECORD], then double-press [PLAY]. Repeat the command to deactivate. Quantization of live recording can also be set in the SEQUENCER CONFIGURATION menu found in the GLOBAL menu.

Press [NO/RELOAD] + one (or several) of the [PADS] to erase a sequence of recorded trigs on a track (or on several tracks) in time with the sequencer, i.e. all steps reached on the pattern playing will be erased, until the keys are released.

To stop both the recording and the playback of the sequencer, press [STOP]. To exit LIVE RECORDING mode while keeping the sequencer playing, press [PLAY]. If LIVE RECORDING mode is active and [REC] is pressed, GRID RECORDING mode will be activated.

11.3.4 STEP RECORDING MODE

STEP RECORDING is a quick and straightforward method of placing trigs on the sequencer. In this recording mode, you insert notes by pressing the [PADS] or using an external MIDI controller. The sequencer then captures the note and automatically advances to the next step. There are two different

modes available, STANDARD mode and JUMP mode.

STANDARD mode

1. Press **[RECORD]** + **[STOP]** to enter STEP RECORDING mode. The **[RECORD]** key starts to double-blink red. (Press **[STOP]** twice while keeping the **[RECORD]** key pressed to toggle between STANDARD and JUMP mode).
2. Press a **[TRIG]** key to select the active step to where you want to start to add note trigs. The active step is shown with a **[TRIG]** key that double-blinks. You can also use **[LEFT]/[RIGHT]** to select the active step or skip steps.
3. Press one or several of the **[PADS]** simultaneously to add trigs to the corresponding tracks on the active step. The active step then automatically advances to the next step. Press **[CHRO]** to add trigs to the active track in CHROMATIC mode. Press **[TRK]** + **[PAD]** to select active track.
4. To remove a trig on the active track or to add a rest (no trig), position the active step on the trig that you want to remove or add a rest to, and then press **[NO/RELOAD]**. The active step then automatically advances to the next step.
5. To add a parameter lock to a trig, press and hold a **[TRIG]** key, and then turn the **DATA ENTRY** knob that controls the parameter you want to lock and set it to the desired value. The graphics become inverted for the locked parameter, and the locked parameter value is displayed.
6. Press **[RECORD]** to exit STEP RECORDING mode.

JUMP mode

In JUMP mode, the **LEN** parameter setting on the TRIG PARAMETER page controls the note length of the trigs you place, and advances the active step the same length. A **LEN** value of 1/16 adds a sixteenth note and advances the sequencer one step. 1/8 adds an eighth note and advances the sequencer two steps. 1/4 adds a quarter note and advances the sequencer four steps and so on. The **LEN** parameter is also parameter locked on every trig you place. If you add trigs from multiple tracks simultaneously the cursor will progress according to the **LEN** setting of the first track played.



- The **[TRIG]** keys display the trigs placed on the active track.
- Press **[TRIG]** + **[YES]** to preview a specific trig on the active track. The preview includes any parameter locks you have placed on that trig.
- If you press and hold a **[PAD]**, and then press one or several other **[PADS]** it will add trigs on multiple tracks on the same sequencer step.
- You can press **[PLAY]** to listen to the sequence while you are programming it. Press **[STOP]** to stop the sequencer and stay in STEP RECORDING mode.
- If you use an external MIDI controller, you must set it to send MIDI data on the defined AUTO CHANNEL. For more information, please see “13.4.3 CHANNELS” on page 57.
- If you use an external MIDI controller, the trig’s **VEL** (velocity) value is determined by the velocity sent from these and is parameter locked. But, if you press and hold **[FUNC]** while inputting notes from an external MIDI controller, the velocity is fixed and determined by the **VEL** parameter setting.
- If you press and hold **[YES]** while you place a trig with the **[PADS]** or an external MIDI controller, the trig length is locked to the time you press the **[PADS]** or the external MIDI controller.
- If you add a new note trig on a previously placed note trig, any parameter locks previously placed on that trig remain as they were.

11.4 RETRIG MENU

When the **[RETRIG]** key is pressed, the retrigger menu for the active track will appear on the leftmost side of the LCD screen. In this menu, a host of retrigger actions can be set. Each of the twelve drum tracks can have its own set of retrigger settings. The retrigger settings are stored to the active kit.

RETRIG	1/16	TUN	SHT	SNP	DEC
LENGTH	1/4				
VEL.CUR	OFF	HRV	HLD	TIC	LEV
ALWAYS ON					

Use the **[ARROW]** keys **[UP]** and **[DOWN]** to highlight one of the retrigger actions (there are more than the

four visible on the screen). Change values using the [ARROW] keys [LEFT] and [RIGHT]. The values can also be set using the LEVEL knob. The retrig actions available in this menu are:

RETRIG Sets the retrig rate (1/1, 1/2, 1/3, 1/4, 1/5, 1/6, 1/8, 1/10, 1/12, 1/16, 1/20, 1/24, 1/32, 1/40, 1/48, 1/64 or 1/80). 1/16 is the nominal retrig rate, one trig per step. 1/32 corresponds to two trigs per step and so on. To trig triplets, for example, set the retrig rate to 1/12 (or 1/24).

LENGTH Sets the duration of the retrig velocity curve in fractions of, or rational or integer multiples of, a step (0,125 - INF). 1/16 is the nominal length of one step. This setting affects the behavior of the velocity curve (see directly below), by defining the boundaries of its envelope.

VEL. CUR Sets the velocity curve fade out/fade in of the retrig (-128 to 127). -128 corresponds to a complete fade out during the set length, -64 fades out to half the velocity during the set length, 0 equals a flat velocity curve with no fade, 64 fades in to half velocity during the set length and 127 fades in completely to full velocity during the set length.

ALWAYS ON Sets retrig lock ON/OFF. When on, the retrig will activate whenever the pad of the active track is pressed without the need to press [RETRIG] first.

Retrigs can be recorded on the sequencer in GRID RECORDING mode as well as in LIVE RECORDING mode. They are recorded as separate trigs. If the retrig speed is greater than the duration of a sequencer step, trigs are created with additional internal steps (i.e. steps with retrig enabled). Trigless trigs are inserted to record pad pressure changes.

Retrigs can be customized on any of the sequencer steps. Press a [TRIG] key, then press the [RETRIG] key or the [ARROW] keys [UP] or [DOWN]. This will bring up a pop-up menu on the LCD screen showing four retrig actions.

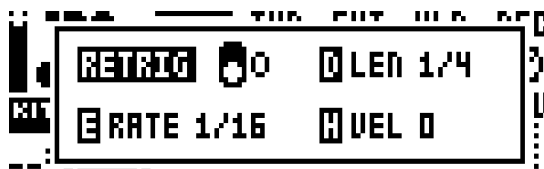

As long as the [TRIG] key is pressed, the pop-up menu will remain visible. In order to activate/deactivate the retrig, press the [RETRIG] key, or turn *DATA ENTRY* knob A. To set the retrig rate, press the [ARROW] keys [UP] and [DOWN] or turn *DATA ENTRY* knob E. Change the length of the retrig velocity curve using *DATA ENTRY* knob D. The velocity curve of the retrig is set using *DATA ENTRY* knob H. The knob works in a bipolar fashion, spanning the range -128 to 127. Negative velocity values fade out the retrig to the set amount, positive values fade it in. The retrig settings in this menu can also be accessed from the RETRIG menu. However, retrig settings placed on a specific trig on the sequencer via the pop-up menu will override the general retrig settings for the active track. Read more about the functionality of retrig settings on the previous page.

11.5 TRACK MENU

Settings and options for the active track are found in this menu. Open the menu by pressing [FUNCTION] + [CHROMATIC]. Browse the list using the [UP]/[DOWN] arrow keys or the LEVEL knob. Select by pressing [YES/SAVE]. Change the track that will be affected by pressing the [TRACK] key + one of the [PADS].



TRIGS SETUP will take you to the quantization settings for the active track. See section “11.7.1 TRIGS SETUP MENU” on page 43.

RELOAD TRACK will reload the active track. Since tracks are a part of patterns which are automatically saved, it will either be reloaded to its original auto-saved state or to a specifically saved state which can be determined by utilizing the **SAVE TRACK** command. Press [NO/RELOAD] + [CHROMATIC] for a shortcut to the **RELOAD TRACK** command.

SAVE TRACK will save changes made to the active track. This is a special feature available in addition to the general, automatic, saving of patterns which occurs when patterns are changed. The feature is useful in situations where an individual track is being worked on, the results are desirable and you want to keep on working with the track while having the ability to revert it to a specifically saved state. The **SAVE**

TRACK command makes this possible. When reloading the track, it will not be reloaded to its original, pattern auto-saved, state, but to the manually saved state. Press **[YES/SAVE] + [CHROMATIC]** for a shortcut to the **SAVE TRACK** command.

11.6 PATTERN MENU

In the **PATTERN** menu patterns can be saved and reloaded. Open the menu by pressing **[FUNCTION] + [SCENE]**. Select between the available commands by using the **[UP]/[DOWN]** arrow keys. Confirm selections with **[YES/SAVE]**.



RELOAD PATTERN will reload the active pattern. It will either be reloaded to its original auto-saved state or to a specifically saved state which can be determined by utilizing the **SAVE PATTERN** command. Press **[NO/RELOAD] + [SCENE]** for a shortcut to the **RELOAD PATTERN** command.

SAVE PATTERN will save changes made to the active pattern. This is a special feature available in addition to the general, automatic, saving of patterns which occurs when patterns are changed. The feature is useful in situations where a pattern is being worked on, the results are desirable and you want to keep on working with the pattern while having the ability to revert to a specifically saved state. The **SAVE PATTERN** command makes this possible. When reloading the pattern, it will not be reloaded to its original, auto-saved, state, but to the manually saved state. Press **[YES/SAVE] + [SCENE]** for a shortcut to the **SAVE PATTERN** command.



The **RELOAD PATTERN** command is great when improvising live. Any changes made to the active pattern, like adding bass line notes or similar, can immediately be undone.

11.7 TRIG MENU

Set the actions for when a note is triggered in the **TRIG** menu. Press the **[TRIG SETUP]** key to access the menu. Change settings using the **DATA ENTRY** knobs. These general settings affect note trigs placed on the sequencer. On any step of the pattern, trigs may be locked to other settings by first pressing and holding a **[TRIG]** key, then changing the settings. Note that the **TRIG** settings are stored along with the active pattern, not to the active kit.

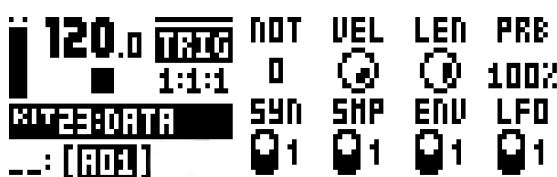

NOT sets the pitch of the note when triggered, ranging from -24 to 24. When **LIVE RECORDING** and playing in **CHROMATIC** mode, the pitch of the **[PADS]** played will override this setting.

VEL sets the velocity at which the note trig on the sequencer is triggered, 1 to 127. In **LIVE RECORDING** mode, the velocity at which the **[PADS]** are tapped will override this setting. This velocity is used when triggering with **[FUNCTION] + [PADS]** or with the **[TRIG]** keys.

LEN sets the length of the note trig. Again, in **LIVE RECORDING** mode, the duration of pressing the **[PADS]** overrides this general setting.

PRB Trig Probability sets the probability that the trigs on the track plays or not. The probability outcome is re-evaluated every time a trig is set to play. The default setting is 100%, meaning that all the trigs on the track plays every time. (0%–100%)

This parameter changes temporarily to display and control **TRC** (Trig Condition) when you add a conditional lock. **TRC** sets the Trig Condition with which a set of conditional rules can be applied to any trig, using a parameter lock. For more information, please see “11.10.3 CONDITIONAL LOCKS” on page 45.



If you have placed a conditional lock on a trig in the sequencer, the trig condition overrides the Trig Probability setting. For example, if you set PRB to 70% and a FILL trig condition on a trig, that trig will only (and always) play when the sequencer is in FILL mode. For more information, please see “11.10.3 CONDITIONAL LOCKS” on page 45.

SYN controls if the synth part of the Sound will be triggered.

SMP controls if the sample part of the sound will be triggered.

ENV controls if the filter envelope will be triggered.

LFO controls if the LFO will be triggered.

11.7.1 TRIGS SETUP MENU

Access the menu by pressing [FUNCTION] + [TRIG SETUP]. Navigate the menu using the [UP]/[DOWN] arrow keys or the *LEVEL* knob. Change settings with the [LEFT]/[RIGHT] arrow keys or any of the *DATA ENTRY* knobs.



GLOBAL QUANTIZE will affect all micro-timed trigs of all tracks. The higher the quantize value, the more all micro-timed trigs will be quantized. Range 0-127.

TRK QUANTIZE will affect all micro-timed trigs of the active track. The higher the quantize value, the more all micro-timed trigs will be quantized. Range 0-127.

TRK SEND MIDI will, when checked, send the tracks note on/off (NOT, LEN) and VEL, sequencer data to the Analog Rytm's MIDI OUT for control of external MIDI devices. The MIDI data is sent on the track's MIDI channel that is set in the CHANNELS menu. For more information, please see “13.4.3 CHANNELS” on page 57.



- If TRK SEND MIDI is checked, the track sends the sequencer data both externally over MIDI and internally to the tracks sound.
- Only the sequencer data for note on/off (NOT, LEN) and VEL parameters are sent over MIDI.

11.8 CLICK TRACK

The CLICK TRACK menu controls the internal metronome of Analog Rytm. Open the menu by pressing [FUNCTION] + [RETRIG]. Use the [UP]/[DOWN] arrow keys or the *LEVEL* knob to scroll through the list of settings. Press [LEFT]/[RIGHT] or any of the *DATA ENTRY* knobs to change the highlighted setting.

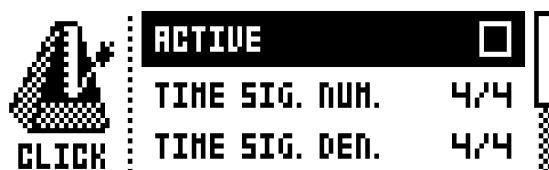

ACTIVE activates/deactivates the metronome. It is also possible, outside of this menu, to keep [FUNCTION] + [RETRIG] pressed for a second to toggle the metronome click on or off.

TIME SIG. NUM controls the note measure of the metronome time signature.

TIME SIG. DEN controls the beat measure of the metronome.

PREROLL controls for how many bars the metronome will sound before the sequencer starts playing. This setting is only relevant when LIVE RECORDING mode is initiated.

VOLUME controls the volume of the click.

11.9 SCALE MENU

The length and timing of the pattern can be changed on this screen. Two modes exist in the SCALE menu. In NORMAL mode all tracks share the same length. In ADVANCED mode each track can have different

lengths. Access the SCALE SETUP menu by pressing [FUNCTION] + [PAGE]. Use the [LEFT] and [RIGHT] arrow keys to select between the available settings. Use the [UP] and [DOWN] keys to adjust the different settings and to select between the two modes.

11.9.1 NORMAL MODE

This is the default mode. In this mode, all tracks of the pattern share the same length and time signature. This screen will appear when the NORMAL setting is active.



The first two settings control the step length of the pattern. The leftmost number selects the number of steps in the pattern. The maximum number of steps available to the pattern is determined by the total length, set by the parameter to the right. This can be either 16, 32, 48 or 64 steps. If 17 steps or more are used in a pattern, the [PAGE] key is, while in GRID RECORDING mode, used to toggle between the different pattern pages.

The rightmost parameter controls the scale (The speed of pattern playback in multiples of the current tempo). It offers seven possible settings, 1/8X, 1/4X, 1/2X, 3/4X, 1X, 3/2X and 2X. A setting of 1/8X will play back the pattern at one-eighth of the set tempo. 3/4X plays the pattern back at three-quarters of the tempo. 3/2X will play back the pattern twice as fast as the 3/4X setting. 2X will make the pattern play at twice the BPM.

Trigs are automatically copied when extending the length of a pattern. If a pattern consists of for example two pages and the pattern length is increased to four pages, the two added pattern pages will be copies of the first two pattern pages.

Press the [PAGE] key for quickly changing the total length of the pattern. Press the [TRIG] keys to quickly change the number of steps of the pattern.

A 2X time signature setting is useful for increasing the base resolution of the step sequencer to 32nd notes. A 3/4X setting is useful when Analog Rytm is playing alongside other instruments set to the same BPM, and you want Analog Rytm to play triplets.

11.9.2 ADVANCED MODE

In this mode, the tracks of the pattern can be assigned individual lengths and scale. Select ADVANCED mode by navigating to the SCALE column using the [LEFT] arrow key. Select **ADVANCED** by using the [DOWN] arrow key. In ADVANCED mode, two columns exist, TRACK and MASTER.

The TRACK column sets the step length and time signature scale of the track. It works just like setting the pattern length and scale in NORMAL mode. The settings will only affect the active track. Press the [TRACK] keys to select the track whose scale settings will be edited.

The MASTER column is only available in ADVANCED mode. Here the master length, the master change length and the general time signature of the pattern are set.

LEN controls the amount of steps the pattern will play before all tracks are restarted. An INF setting will make the tracks of the pattern loop infinitely, without ever being restarted. Note that this setting also affects for how long the active pattern will play before a chained pattern will start playing. This can be overridden by the CHNG parameter.

CHNG controls for how long the active pattern will play before a cued or chained pattern will begin to play. This setting is important when for example LEN is set to INF. If no CHNG setting is made, the pattern will play infinitely and the next pattern will thus not be cued. But if CHNG, for instance, is set to 64, the pattern will behave like a pattern consisting of 64 steps in terms of cueing and chaining.

MASTER SCALE is the rightmost setting. It sets the general time signature of the pattern.



If INF is selected the active pattern will play infinitely, making it impossible to change to another pattern (when SEQUENTIAL pattern play mode is used).



Press [FUNCTION] + [UP]/[DOWN] to set the lengths in increments of 16.

11.10 SEQUENCER FEATURES

11.10.1 PARAMETER LOCKS

Parameter locks enable all trigs to have their own unique parameter values. The note trigs of a drum track can have, for example, different pitch, amp or filter settings. All parameters found on the PARAMETER pages are possible to parameter lock and parameter locks can be applied to all types of tracks. Additionally, all settings on the TRIG page may be locked (see “TRIG MENU” on page 38). For a complete overview of all parameters on the PARAMETER pages, check out “APPENDIX A: DRUM TRACK PARAMETERS” on page 72.

To apply parameter locks in GRID RECORDING mode, press and hold the [TRIG] key of a trig. Adjust the parameters you want to lock using the *DATA ENTRY* knobs. The graphics in LCD will become inverted for the locked parameter and the locked parameter value will be displayed. The <TRIG> LED of the locked trig will begin to flash rapidly, indicating the trig now contains a parameter lock. Remove a single parameter lock by holding [TRIG] + pressing the *DATA ENTRY* knob of the locked parameter. By removing a note trig and entering it again, all parameter locks will be erased from the trig.

In CHROMATIC mode, a note pitch parameter lock will be shown with a red color pad when you press and hold the [TRIG] key containing such a lock.

In LIVE RECORDING mode, turning a *DATA ENTRY* knob, or playing the [PADS] in CHROMATIC mode, will input parameter locks to the active track. Note trigs will be locked accordingly, and trigless locks containing the locks will be placed on the sequencer steps not containing note trigs.

To remove all the parameter locks of the active track while LIVE RECORDING mode is active and the sequencer is running, press and hold [FUNCTION] + [NO/RELOAD]. All steps reached on the pattern playing will be erased. Sound locks will not be erased.

To remove specific parameter locks in real time, while LIVE RECORDING mode is active and the sequencer is running, press and hold [NO/RELOAD] and then press the *DATA ENTRY* knob corresponding to the parameter that will be removed.

To erase the recorded trigs on a specific track (or on several tracks) while LIVE RECORDING mode is active and the sequencer is running, press and hold [NO/RELOAD] + one (or several) of the [PADS]. All steps reached on the pattern playing will be erased. Sound locks will not be erased.



Up to 72 different parameters can be locked in a pattern. A parameter counts as one (1) locked parameter no matter how many trigs that lock it. If for example the cutoff parameter of the filter is locked on every sequencer step, there are still 71 other parameters that can be locked.

11.10.2 SOUND LOCKS

All drum Sounds in the Sound pool of the active project can be changed per sequencer step. Press and hold a note trig and turn the *LEVEL* knob. The Sound pool list will appear. Scroll the list using the *LEVEL* knob, select the Sound you want to assign to the note trig and then release the [TRIG] key. The <TRIG> LED will start to flash. Press and hold the [TRIG] key of the note trig to show the assigned Sound.



Remember, all Sounds may not be loaded to all tracks. If a Sound in the list is incompatible with the active track it may not be sound locked. When browsing the Sound pool, Sounds that are incompatible with the active track are shown with a flashing (!) symbol on the LCD screen. As are empty Sound pool slots.



The first position in the Sound pool list, titled TRACK SOUND, is the default selection. It will play the corresponding track Sound of the active kit.

11.10.3 CONDITIONAL LOCKS

On the TRIG page, there is a parameter called TRC (Trig Condition) with which a set of conditional rules can be applied to any trig, using a parameter lock. Each setting is a logical condition, which will determine whether or not the sequencer note will be triggered.

The sequencer needs to be in Fill Mode to activate the parameter locks called FILL (see below). Fill Mode is activated, for one pattern cycle, by pressing [YES] + [PAGE]. It will become active when the pattern loops, and remain active until it loops again.

It is also possible to activate Fill Mode at any time, and for any duration, by pressing and holding the [PAGE] key when the pattern is playing (GRID RECORDING mode can not be active). The fill mode will be active for as long as the key is being held down.

Press and hold [PAGE] + [YES], and then release [PAGE] before you release [YES] to latch FILL mode. Press [PAGE] again to unlatch FILL mode.

Fill Mode is useful for example when you want to create a temporary variation, such as a drum fill, in your pattern.

The following conditional rules may be set using the TRC parameter, **DATA ENTRY** knob **D** (on the TRIG page), when a parameter lock is applied to a trig:

X% is a probability condition. There is an X% chance that the trig will be active.

FILL is true (activates the trig) when FILL mode is active (see above).

$\overline{\text{FILL}}$ is true when FILL is false. A trig with this trig condition is active when you are not in FILL mode.

PRE is true if the most recently evaluated trig condition on the same track was true. (PRE and $\overline{\text{PRE}}$ conditions are ignored and not evaluated.)

$\overline{\text{PRE}}$ is true when PRE is false. A trig with this trig condition is active if the most recently evaluated trig condition on the same track was not true. (PRE and $\overline{\text{PRE}}$ conditions are ignored and not evaluated.)

Example 1: Trig 1, 50% = **True** > Trig 2, $\overline{\text{PRE}}$ = **False** > Trig 3, $\overline{\text{PRE}}$ = **False** > Trig 4, PRE = **True**

Example 2: Trig 1, 50% = **False** > Trig 2, $\overline{\text{PRE}}$ = **True** > Trig 3, $\overline{\text{PRE}}$ = **True** > Trig 4, PRE = **False**

NEI is true if the most recently evaluated trig condition on the neighbor track was true. (PRE and $\overline{\text{PRE}}$ conditions on the neighbor track are ignored and not evaluated.) The neighbor track is the track before the active track. For example, track 3 is the neighbor track of track 4. NEI and NEI conditional trigs on track 4 evaluate the conditional trigs placed on track 3. The NEI condition is false if no conditional trigs exist on the neighbor track.

$\overline{\text{NEI}}$ is true when NEI is false. A trig with this trig condition is active if the most recently evaluated trig condition on the neighbor track was not true. (PRE and $\overline{\text{PRE}}$ conditions on the neighbor track are ignored and not evaluated.)

1ST is true the first time the pattern plays (when looped).

$\overline{\text{1ST}}$ is true when 1ST is false. A trig with this trig condition is always active apart from the first time the pattern plays (when looped).

A:B **A** sets how many times the pattern (or track, if the track length is shorter than the pattern length) plays before the trig condition is true. **B** sets how many times the pattern (or track, if the track length is shorter than the pattern length) plays before the count is reset and starts over again. This cycle then repeats until you stop the sequencer.

For example:

With the setting 1:2, the trig condition is true the first time the pattern plays and then the third, the fifth, and so on.

With the setting 2:2, the trig condition is true the second time the pattern plays and then the fourth, the sixth, and so on.

With the setting 2:4, the trig condition is true the second time the pattern plays and then the sixth, the tenth, and so on.

With the setting 4:7 the trig condition is true the fourth time the pattern plays and then the eleventh, the eighteenth, and so on.



- Conditional parameter locks are a great way to add variety to a pattern. To set up a grid of mutually exclusive or conclusive note trigs across any of the synth tracks, and throwing some probability locks in there as well (perhaps, in turn, also sporting an array of logically conditioned trigs) is a neat way to make the most minimal of compositions come alive with randomness.
- Note that random or arbitrary variety, while fun and interesting, is not the only way of using conditional trigs. They may also be used, for example, to have two different melodic or percussive sequences on the same track, one of which is activated only when fill mode is active.

11.10.4 TRIG MUTE

The TRIG MUTE screen allows you to add mute masks on a sequencer pattern. Each track can have its own trig mute trigs. Open the menu by pressing [FUNCTION] + [BANK A/E].



TRIG MUTES

Enter trig mute trigs by pressing the [TRIG] keys. While on the TRIG MUTE screen, the trigs entered will mute any trigs placed on the active track, given the trigs are located on the same sequencer steps. If you wish to edit the step property on all tracks simultaneously, not just the active track, press and hold [FUNCTION] key and then enter the trigs. The steps containing note trigs will be shown with dimly lit <TRIG> LEDs above their [TRIG] keys.



- Trig mutes can be quickly added to note trigs or trigless locks. Keep the note trig or trigless lock pressed and press [BANK A/E]. A trig mute trig will automatically be placed on the same sequencer step as the note trig/trigless lock.
- Press a note trig/trigless lock to quickly see if a trig mute trig is placed on the same sequencer step as the trig. If that is the case, the <BANK A/E> LED will light up.
- Trig mutes are good for experimenting with the feel of tracks when playing live. The last eight steps of a bass line track could, for example, be muted to build suspense.

11.10.5 ACCENT

Adding accent trigs is useful for quickly changing the velocity for chosen steps of a track. Accent level is a destination for modulation, which means it can be affected by, for example, LFOs. Open the ACCENT menu by pressing [FUNCTION] + [BANK B/F].



ACCENT

32

Select the track that will be affected by pressing the corresponding [TRACK] key. Select the accent value by turning the *LEVEL* knob. The higher the value, the more accentuation will be added to accent trigs.

While the ACCENT menu is open, the sequencer will display accent trigs. Place or remove accent trigs by pressing the [TRIG] keys. If you wish to edit the step property on all tracks simultaneously, not just the active track, press and hold [FUNCTION] key and then enter the trigs. If an accent trig is placed on the same sequencer step as a note trig, the note trig will be accentuated.



- A note trig can be quickly accented. Keep the note trig pressed and press [BANK B/F]. An accent trig will automatically be placed on the same sequencer step as the note trig.
- Press a note trig/trigless lock to quickly see if an accent trig is placed on the same sequencer step as the trig. If that is the case, the <BANK B/F> LED will light up.

11.10.6 SWING

Adjust the swing setting of the pattern, to employ a propulsive, rhythmic groove. Access this menu by pressing [FUNCTION] + [BANK C/G].



PATTERN SWING

50%

Set the SWING ratio to 51-80%, by turning the *LEVEL* knob or by pressing [ARROW] keys [UP] or [DOWN]. The default setting is equal spacing, 50%. Customize the swing pattern, shown by lit <TRIG> LEDs, using the [TRIG] keys.

11.10.7 SLIDE

The PARAMETER SLIDE menu makes it possible for the parameter values of two separate note trigs or trigless locks of a track to slide between each other. Open the menu by pressing **[FUNCTION] + [BANK D/H]**. When this menu is active and **[TRIG]** keys are pressed, slide trigs will be placed on the sequencer. If you wish to edit the step property on all tracks simultaneously, not just the active track, press and hold **[FUNCTION]** key and then enter the trigs.



For a parameter value to slide between two trigs, it needs to be locked on one of the trigs. A locked parameter value will slide to the unlocked value and vice versa. To make the parameter value slide, place a slide trig on the same sequencer step as the trig whose parameters you want to slide. The speed of the slide is relative to the current tempo, and the slide is completed when the next trig is reached. Several parameter values can slide at the same time.



- Parameter slides can be quickly added to note trigs or trigless locks. Keep the note trig or trigless lock pressed and press **[BANK D/H]**. A parameter slide trig will automatically be placed on the same sequencer step as the note trig/trigless lock.
- Press a note trig/trigless lock to quickly see if a parameter slide trig is placed on the same sequencer step as the trig. If that is the case, the **<BANK D/H>** LED will light up.

11.10.8 COPY, PASTE AND CLEAR OPERATIONS

Patterns, track pages, tracks and trigs can be copied, pasted and cleared.

The active pattern can be copied to either another location in the same bank or to a location in another bank. To perform a pattern copy operation, GRID RECORDING mode must be inactivated. Copy the pattern by pressing **[FUNCTION] + [REC]**. Select another pattern and paste the copied pattern to this location by pressing **[FUNCTION] + [STOP]**. The operation can be undone by pressing **[FUNCTION] + [STOP]** again. Clear a pattern by pressing **[FUNCTION] + [PLAY]**. Undo the operation by repeating the key presses.

After selecting a pattern, and before releasing any key, **[REC]**, **[PLAY]** and **[STOP]** can be pressed to copy, clear or paste patterns.

Individual sequencer tracks can be copied, pasted and cleared in the same way as patterns. To do so, GRID RECORDING mode needs to be active.

A single track page may also be copied, pasted and cleared. It is similar to copying/pasting/clearing a track, but will only affect the active track page. GRID RECORDING mode needs to be active. Select the track page of choice by pressing the **[PAGE]** key. Copy by pressing **[PAGE] + [REC]**. Select a new track page and press **[PAGE] + [STOP]** to paste. Undo by pressing **[PAGE] + [STOP]** again. Press **[PAGE] + [PLAY]** to clear the active track page. Undo the operation by repeating the key presses.

Trigs, complete with all parameter lock settings, can be copied, pasted and cleared as well. GRID RECORDING mode needs to be active to access this functionality. Press and hold a trig and press **[REC]** to perform the copy operation. Paste by holding another **[TRIG]** key and pressing **[STOP]**. It is also possible to copy more than one trig. Press and hold the trigs you wish to copy, and then press **[RECORD]**. Press and hold the **[TRIG]** key to where you want to paste, and then press **[STOP]** to paste the copied sequence of trigs. When pasting, the copied trigs are placed in the same relation to each other as they had when they were copied. The destination trig acts as the starting point for the sequence of copied trigs. Clear trig locks by holding one or more trigs and press **[PLAY]**.

11.10.9 QUICK SAVE AND RELOAD COMMANDS

Kits, Sounds, tracks, patterns and songs can instantly be saved and reloaded. When reloading, settings will revert to their saved state.

- To quick save a kit, press **[YES/SAVE] + [FX]**. This command is the same as the SAVE KIT command found in the KIT menu, covered on page 20.
- To quick save the track Sound of the active track, press **[YES/SAVE] + [MUTE]**. This command is the same as the STORE TRACK SOUND command found in the SOUND MANAGER menu, covered on page 26.

- To quick save a track, press **[YES/SAVE] + [CHROMATIC]**. The operation is the same as the SAVE TRACK command, covered on page 46.
- To quick save the active pattern, press **[YES/SAVE] + [SCENE]**. The operation is the same as the SAVE PATTERN command, covered on page 38. This is useful in order to create a restore point before you start a session of live tweaking that might not turn out the way you want.
- To quick save a song, press **[YES/SAVE] + [PERF]**. The command is the same as the SAVE command found in the SONG menu, covered on page 49.
- To quick reload a kit, press **[NO/RELOAD] + [FX]**. This command is the same as the RELOAD KIT command found in the KIT menu, covered on page 20. This is useful live after a kit has been subject to improvised changes.
- To quick reload the track Sound of the active track, press **[NO/RELOAD] + [MUTE]**. This is the same as kit reload, but only on the active track (not all tracks).
- To quick reload a track, press **[NO/RELOAD] + [CHROMATIC]**. The operation is the same as the RELOAD TRACK command, covered on page 46.
- To quick reload the active pattern, press **[NO/RELOAD] + [SCENE]**. The operation is the same as the RELOAD PATTERN command, covered on page 38. Only useful until another pattern is selected, as an undo operation after live changes.
- To quick reload a song, press **[NO/RELOAD] + [PERF]**. The command is the same as the RELOAD command found in the SONG menu, covered on page 49.

12. CHAINS AND SONGS

Chains are sequences that consist of one or more patterns. Chains are used to form songs.

256 pattern entries are available to the 64 chains. For example, one chain can consist of 256 patterns or two chains can consist of 128 patterns each. In most scenarios, however, using 2-8 patterns in a chain will be enough.

One song is always active and worked on. Songs contain two main forms of entries, song rows, and a scratch pad row. The active song row is visible in the bottom left part of the LCD. If a scratch pad row is active, the graphics will show “_.”. The scratch pad row is by default placed after all song rows.

Each song row contains a chain. These entries are saved together with the song. The scratch pad row also contains a chain or a pattern and is also saved as part of the song. The purpose of the scratch pad row is to enable experimentation with chains and patterns without affecting already programmed song rows.

12.1 CHAINS

If the active song row or scratch pad row contains a chain, all patterns in the chain will be played when activating the CHAIN mode by pressing **[CHAIN MODE]**. When deactivating the mode, and SONG mode is not active, the currently active pattern will be played over and over. The currently active pattern, and any other patterns in the chain are visible in the lower left corner of the LCD screen.

Chains can be created even if CHAIN mode is deactivated. When creating chains this way, two methods exist, detailed chain mode and quick chain mode. Create chains according to detailed mode by pressing **[CHAIN MODE]** + **[LEFT]/[RIGHT]** to move the chain cursor. It can either be placed before a pattern, on a pattern or after a pattern. If the cursor is placed before a pattern and a new pattern is selected by pressing **[BANK X/X]** + **[TRIG]**, the selected pattern will be inserted before the pattern located after the cursor. If the cursor is highlighting a pattern and a new pattern is selected, the highlighted pattern will be replaced. When activating CHAIN mode, the patterns in the chain will be played in sequence. The chain will be looped once the final pattern of the chain has played. To create chains in quick mode, press **[BANK X/X]** and then press the **[TRIG]** keys in the same order as you want the chained patterns to play (and keep the previous trig key pressed while you press the next one, the one after that and so on so that the sequencer can recognize that you're building a chain and not just switching patterns). Please note that the previous chain will be erased when you create a chain using quick chain mode.

Pressing **[CHAIN MODE]** + **[NO/RELOAD]** will, depending on the location of the chain cursor, either erase the pattern located before the cursor or the one highlighted by it.

Pressing **[FUNCTION]** + **[CHAIN MODE]** will create a new, blank, scratch pad row. The scratch pad row will be placed at the very bottom of the song row list (which can be seen when opening the SONG EDIT menu). The content of the previous scratch pad row will be added as a new song row following the last song row.



CHAIN mode is ideal when improvising live. When CHAIN mode is deactivated, and only the active pattern is looping, create a chain and then activate CHAIN mode. At any time, exit CHAIN mode to loop one pattern only. Add and remove patterns to create a completely new chain and activate CHAIN mode again. By creating new chains through pressing **[FUNCTION] + **[CHAIN MODE]**, improvised songs can quickly be created.**

12.2 SONGS

Songs are essentially patterns and chains structured to form a longer sequence. To enter SONG mode, press the **[SONG MODE]** key. The <SONG> LED will light up, indicating SONG mode is active. The active song will start to play, row by row. If the active song row is the scratch pad row (in its bottom-of-the-stack default position) it will play through its chain of patterns once, then stop. If the scratch pad row has been moved within the song, it will play the following song row. The song row playing is shown in the lower left corner of the LCD screen.

12.2.1 SONG EDIT MENU

Songs are created in the SONG EDIT menu, which is accessed by pressing **[FUNCTION]** + **[SONG MODE]**.

```

--: 1*  A01 A02
00: 1*  A01
01: 3*  A01 A02 A03

```

```

120.0
0001:1
0000
0000
0000

```

Songs are played row by row, starting from the top and moving towards the bottom. If a song row contains a chain, all patterns in the chain will play before the song play position moves to the next row. The song play position is shown with inverted pattern number graphics. In the top right corner of the LCD screen, the BPM and the amount of played bars and beats is shown.

To navigate between song rows as well as patterns assigned to the song rows, use the **[ARROW]** keys. When the song cursor highlights a pattern position, the pattern number becomes enclosed by a square. When the song cursor is placed before or after a pattern, it will form a thin line.

To start playing a Song from the beginning, double-press **[STOP]**. The song play position will automatically be moved to the first pattern of the first song row. Songs can, however, start playing from any pattern position. Highlight a pattern position by moving the song cursor using the **[ARROW]** keys. Press **[YES/SAVE]** to select this position. The graphics will become inverted, indicating this is the song play position. Press **[PLAY]** to start playing the Song from this position.



Copy, paste and clear commands can be executed on the song rows.

12.2.2 ADDING SONG ROWS AND ASSIGNING PATTERNS AND CHAINS

Press **[FUNCTION]** + **[YES/SAVE]** to add a song row. The new song row will be inserted below the row on which the cursor is, and the pattern A01 will automatically be assigned to the new row. To assign another pattern to the song row, use the **[ARROW]** keys to move the song cursor so the pattern assigned to the row becomes highlighted and then press a **[BANK X/X]** key + a **[TRIG]** key. In general, the pattern assigning procedure is the same as when selecting a pattern, covered in the section “11.1.1 SELECTING A PATTERN” on page 37.

To add a chain to a song row, select a song row and press the **[RIGHT]** arrow key. The song cursor will move from the pattern position and form a thin, standing line. Press a **[BANK X/X]** key + a **[TRIG]** key to select the pattern that will be added to the chain.

Remove a pattern in a chain by highlighting it with the song cursor and pressing **[FUNCTION]** + **[NO/RELOAD]**.

If a song row contains a chain, individual patterns can be rearranged in the chain. Select the pattern by highlighting it with the song cursor and press **[FUNCTION]** + **[LEFT]/[RIGHT]**.

Move a song row up or down in the song by moving the song cursor to the song row and pressing **[FUNCTION]** + **[UP]/[DOWN]**.

Erase a song row, one pattern at a time, by pressing **[FUNCTION]** + **[NO/RELOAD]** repeatedly.

12.2.3 ADDING REPEATS AND MUTES

Various extra information can be entered for song rows and the pattern or patterns assigned to the song rows.

Repeat a song row a chosen number of times by moving to the leftmost position of the song row with the cursor. Turn **DATA ENTRY** knob **A** to select how many times the song row will be repeated.

```

  __: 1×  A01 A02
  00: 1×  A01
  01: 3×  A01 A02 A03

```

120.0
0025:2
0002:1

You can selectively mute tracks of any pattern while in song edit mode. First, make sure **MUTE** mode is on. If not, press **[MUTE]** and make sure the adjacent LED is fully lit. Then, in the song editor, place the cursor on the pattern you wish to mute tracks on using the **[ARROW]** keys and press **[YES/SAVE]**. Press and hold the **[SONG MODE]** key + press the **[PADS]** of the drum tracks you wish to mute.

```

  __: 1×  A01 A02
  00: 1×  A01
  01: 3×  A01 A02 A03

```

120.0
0001:1
0000
00--
00--

The mute graphics on the bottom right of the LCD screen will show the muted tracks with a (-) symbol. Unmuted tracks are shown as squares. To mute tracks of another pattern in the song, simply move the cursor to that pattern using the [ARROW] keys and press [YES/SAVE]. Song mutes are pattern specific. Different patterns can have different song muted tracks. Note that it is the pattern at a specific position in the song which will be affected: if for example, pattern A01 is used in multiple places in the song and the top left instance of it is track muted, all other instances of pattern A01 will remain unchanged. To mute the tracks of another pattern position, simply place the cursor on top of it, press [YES/SAVE] and add mutes as instructed above. In addition to being shown on the LCD screen, muted tracks in a song are also shown with dimly lit green color <PADS> when a pattern is highlighted. Unmuted tracks will, as in regular MUTE mode, exhibit green color <PADS>.



When a song contains programmed mutes, the LED adjacent to the [MUTE] key and the LEDs adjacent to the [SONG MODE] and [CHAIN MODE] keys will be dimly lit, whether any of these modes are active or not. This feature is intended to help show that there are active song mutes in one of the patterns. Additionally, whenever a pattern containing song mutes is selected, and MUTE mode is active, the <PADS> sporting programmed mutes will exhibit a dim green color (unless the song muted tracks are already muted in regular MUTE mode, in which case the <PADS> will simply be unlit).



Even outside of SONG EDIT, song mutes may be instantly added to any track of the active pattern in a chain or song. Just activate MUTE mode by pressing the [MUTE] key. Then, as in SONG EDIT, press and hold [SONG MODE] and tap the [PADS] of the tracks you wish to mute.

12.2.4 SONG MENU

In the SONG menu, songs can be saved, loaded renamed et cetera. Access the menu by pressing [FUNCTION] + [PERF].



RELOAD will reload the active song. It will be restored to its saved version. Press [NO/RELOAD] + [SONG] for a shortcut to this command.

LOAD will open a menu where saved songs can be loaded. The active song is shown with inverted graphics.

SAVE will save the active song to one of the 16 song slots. The active song is shown with inverted graphics. Press [YES/SAVE] + [SONG] for a shortcut to this command.

CLEAR will clear the active song from all content.

EDIT will open the EDIT menu. It is the same menu as accessed by pressing [FUNCTION] + [SONG MODE]. See page 47 for more info about this menu.

RENAME will open a menu where the active song can be renamed.

13. GLOBAL MENU

The GLOBAL menu offers settings that affect Analog Rytm on a global level. Global sequencer, MIDI and track routing settings are made here. Up to four Global slots are available, each with its individual settings.

Access the menu by pressing [FUNCTION] + [TRACK]. Scroll the list by using [UP]/[DOWN] or the LEVEL knob. Open a highlighted menu by pressing [YES/SAVE].

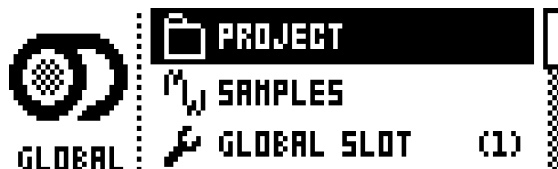

13.1 PROJECT

This is where you manage the projects. This menu is covered in the section “9. PROJECTS” on page 25.

13.2 SAMPLES

Manage your samples here. On the main screen, seen below, you can access one of two main directories, FACTORY or INCOMING. In the FACTORY directory, several preset samples can be found in one of the ten subdirectories. The INCOMING directory, on the other hand, is the default destination for samples sent to the Analog Rytm +Drive storage via the C6 utility software. Press [YES/SAVE] to open a directory.



To open a subdirectory, simply highlight it using the [ARROW] keys and press [YES/SAVE]. To exit a directory, select the item labeled “..” at the very top of the screen and press [YES/SAVE]. Do this repeatedly to return to the top of the directory hierarchy. To discern directories from sample files, all directories, including the directory exit row, “..”, are labeled with a (D) at the very end of the row. When browsing a directory in the +Drive, a sample assigned to one of the 127 sample slots of the active project will have its slot number shown within brackets, as seen below.

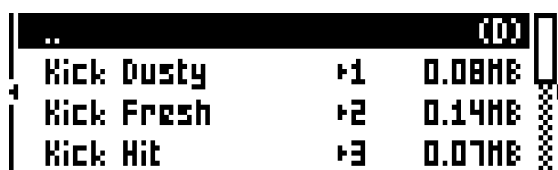

13.2.1 LOADING, UNLOADING OR REPLACING A SAMPLE

The following is an example of how to load one or several of the preset samples to the active project. First, open the FACTORY directory. Second, open the PERCUSSION directory (the seventh item in the list). Here, highlight the first sample, “Agogo High” and press [YES/SAVE] to tick it. Browse the list and tick a few other samples. Any sample may be previewed (played back by the voice of the active track) by first highlighting it and then pressing [FUNCTION] + [YES/SAVE]. Circa, ten seconds of the sample will be previewed. Third, press the [RIGHT] arrow key. A menu will appear on the right side of the screen.



Select LOAD TO PROJECT and press [YES/SAVE]. The samples you selected (ticked) will now appear in the first available empty slots out of the 127 user sample slots of the active project. To view the user samples currently in the RAM of the active project, press the [LEFT] arrow key twice. This will bring up the left side menu.



Select VIEW RAM and press [YES/SAVE]. A list will appear, showing all 127 user sample slots. A circle at the very right end of the row means that the sample is currently unused in the active project.

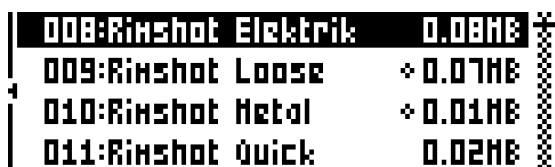

On this screen, the 127 user samples may be unloaded individually or collectively to empty the slots. Scroll the list using the [ARROW] keys [UP]/[DOWN] or the LEVEL knob. Press [YES/SAVE] to tick individual samples, or bring up the right-hand menu by pressing [RIGHT] and choose SELECT ALL. On the right-hand menu, select UNLOAD to empty the slots of the ticked samples.



Any sample in the RAM may be individually replaced. Simply highlight the slot containing the sample you wish to replace, open the right-hand menu by pressing [RIGHT] and select REPLACE. Browse the directories of the +Drive, locate the desired sample and press [YES/SAVE] to place it in the previously highlighted sample slot. If you wish to go back to browsing the +Drive storage directories, press [LEFT] twice and select VIEW +DRIVE.

13.2.2 REMOVING UNUSED SAMPLES FROM RAM

You can use this feature to remove all samples that are not used in any pattern in the project from the RAM memory. The samples are not removed from the +Drive.

1. Press [FUNCTION] + [TRACK], and then open the SAMPLES menu.
2. Press the [LEFT] arrow key. A menu will appear on the right side of the screen. Select VIEW RAM and press [YES].
3. Press the [RIGHT] arrow key. A menu will appear on the right side of the screen. Select SELECT UNUSE, and then press [YES].
4. Select UNLOAD. A warning popup will appear asking "UNLOAD X SAMPLES? CONFIRM? Y/N". Press [YES] to remove all unused samples.

13.2.3 TRANSFERRING SAMPLES FROM A COMPUTER TO ANALOG RYTM

1. Connect the Analog Rytm to the computer via USB.
2. Open the Elektron Transfer software (Available on the Elektron website) on your computer.
3. On the Transfer CONNECTIONS page, set the MIDI IN and OUT ports to your Analog Rytm.
4. In Transfer, click the EXPLORE tab to open the EXPLORE page.
5. On the top right side, in the drop-down menu, select "Samples".
6. On the top left side in the drop-down menu, make sure "My Computer" is selected.
7. Under "My Computer" navigate to the files or folders you want to transfer.

8. Drag and drop the files or folders to your preferred location on your device. Transfer automatically converts all audio files to 16 bit, 48 kHz, mono audio files, the Analog Rytm's native audio format.

13.2.4 CREATING A NEW DESTINATION DIRECTORY

On the main screen, press [ARROW] key [RIGHT] to access the right side menu. Select CREATE DIR to create a new directory by pressing [YES/SAVE]. A naming screen will appear. See section "6.5 THE NAMING SCREEN" on page 17. Give your new destination directory an appropriate name. Once the new directory has appeared on the main screen, open it by pressing [YES/SAVE]. In the initially empty directory, press [ARROW] key [LEFT] to open the left side menu. Highlight UPLOAD HERE and press [YES/SAVE].

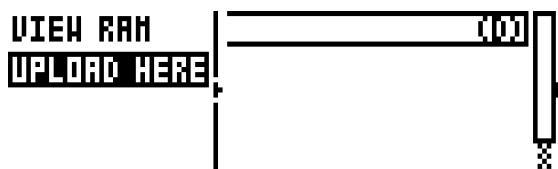

Consequently, samples sent from a computer will be written into the new destination directory. Note that any new or existing directory can be set to be the destination directory in a similar manner, accessing the left side menu, except for the FACTORY directory which is write-protected. Any directory (again, except the FACTORY directory) can be deleted or renamed by highlighting it, accessing the right-hand menu and selecting DELETE DIR or RENAME.



- Make sure you have the latest version of the Elektron Transfer software installed on your computer. You can download the free Transfer software and the Transfer User Manual from the Support section of the Elektron website.
- If MIDI+USB is selected in the INPUT FROM and/or OUTPUT TO settings on the PORT CONFIG menu, MIDI data transfers will limit the USB speed. When sending or receiving large chunks of data, make sure you use only the USB setting.

13.2.5 TRANSFERRING SAMPLES TO A COMPUTER FROM ANALOG RYTM

1. Connect Analog Rytm to the computer via USB.
2. Open the Elektron Transfer software (Available on the Elektron website) on your computer.
3. On the Transfer CONNECTIONS page, set the MIDI IN and OUT ports to your Analog Rytm.
4. In Transfer, click EXPLORE to open the EXPLORE page.
5. On the EXPLORE page on the right side under ANALOG RYTM, navigate to the samples you want to transfer
6. Drag and drop the samples to your preferred folder under MY COMPUTER.

13.3 GLOBAL SLOT

Selects which of the four Global slots to use. Select the active slot by using the [LEFT]/[RIGHT] arrow keys. Press [YES/SAVE] to confirm the selection. All changes made to a Global slot are automatically saved. A slot stores the current configuration of the sequencer, MIDI and track routing settings. All changes made to a Global slot are automatically saved.

13.4 MIDI CONFIG

In this menu, various sub-menus dealing with the MIDI functionality of Analog Rytm are found.



13.4.1 SYNC

Controls how Analog Rytm receives and sends MIDI clock and transport commands. Change settings by using the [LEFT]/[RIGHT] arrow keys or the [YES/SAVE] key.



CLOCK RECEIVE will when active make Analog Rytm respond to MIDI clock sent from external devices.

CLOCK SEND will when active make Analog Rytm transmit MIDI clock.

TRANSPORT RECEIVE will when active make Analog Rytm respond to system real time messages like play, stop, continue and song position pointer.

TRANSPORT SEND will when active make Analog Rytm send out system real time messages like play, stop, continue and song position pointer.

PRG CH RECEIVE will when active make Analog Rytm respond to incoming program change messages, which is useful when wanting to select patterns externally. The MIDI channel that will listen to incoming program change messages is set in the MIDI CHANNELS menu, covered on page 56.

PRG CH SEND will when active send program change messages when patterns are changed. The MIDI channel that will send program change messages is set in the MIDI CHANNELS menu, covered on page 56.

13.4.2 PORT CONFIG

MIDI port related settings are found in this menu. Change settings by using the [LEFT]/[RIGHT] arrow keys.



TURBO SPEED press [YES/SAVE] to start the turbo speed negotiation. Speed is chosen automatically. Please note that you must use a MIDI interface that supports the Turbo-MIDI protocol.

OUT PORT FUNCTIONALITY selects what type of signal the MIDI OUT port will send.

- MIDI makes it possible for the port to send out MIDI data.
- DIN 24 will make the port send DIN 24 sync pulses. No MIDI data can be sent on the port when this option is selected.
- DIN 48 will make the port send DIN 48 sync pulses. No MIDI data can be sent on the port when this option is selected.

THRU PORT FUNCTIONALITY selects what type of signal the MIDI THRU port will send. The settings are the same as for OUT PORT FUNCTIONALITY.

INPUT FROM selects the source Analog Rytm will receive MIDI data from.

- DISABLED will make Analog Rytm disregard any incoming MIDI data.
- MIDI will make Analog Rytm listen only to MIDI data sent to the MIDI IN port.
- USB will make Analog Rytm listen only to MIDI data sent to the USB port.
- MIDI+USB will make Analog Rytm listen to MIDI data sent to both the MIDI IN and USB ports.

OUTPUT TO selects the destination to which Analog Rytm will send MIDI data.

- DISABLED will stop Analog Rytm from sending out any MIDI data.
- MIDI will make Analog Rytm send MIDI data to the MIDI OUT port only.
- USB will make Analog Rytm send MIDI data to the USB port only.
- MIDI+USB will make Analog Rytm send MIDI data to both the MIDI OUT and USB ports.



If MIDI+USB is selected in the OUTPUT TO settings, MIDI data will limit the USB speed. When sending large chunks of data, make sure you only use the USB setting.

OUTPUT CH selects whether the [PADS] and the knobs will send data on the auto channel or the track

channel.

PARAM OUTPUT selects what type of MIDI messages the **DATA ENTRY** knobs will send. For information about which CC/NRPN parameters that will be sent, please see “APPENDIX C: MIDI” on page 79.

- NRPN will make the knobs send out NRPN MIDI messages.
- CC will make the knobs send out CC MIDI messages.

ENCODER DEST controls whether the **DATA ENTRY** and **LEVEL** knobs will send MIDI data or not. When set to INT, no MIDI data will be sent. When set to INT + EXT, MIDI will be sent internally as well as externally.

PAD DEST controls whether the **[PADS]** will send MIDI data or not. When set to INT, no MIDI data will be sent. When set to INT + EXT, MIDI will be sent internally as well as externally. When set to EXT, MIDI will only be sent externally.

PRESSURE DST controls whether varying pressure applied to the **[PADS]** will send MIDI data or not. When set to INT, no MIDI data will be sent. When set to INT + EXT, MIDI will be sent internally as well as externally. When set to EXT, MIDI will only be sent externally.

MUTE DEST controls whether activating/deactivating mutes will send MIDI data or not. When set to INT, no MIDI data will be sent. When set to INT + EXT, MIDI will be sent internally as well as externally. When set to EXT, MIDI will only be sent externally.

RECEIVE NOTES will when active, make it possible to play Analog Rytm using an external MIDI keyboard.

RECEIVE CC/NRPN will when active make it possible to control Analog Rytm parameters from an external MIDI device sending CC/NRPN data.

13.4.3 CHANNELS

This menu handles the MIDI channel configuration.

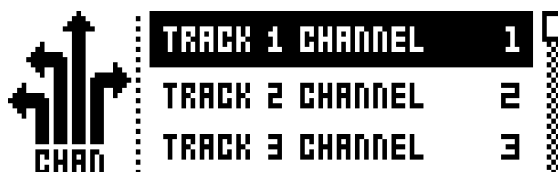

TRACK 1-12, FX selects dedicated MIDI tracks that will control the drum and FX tracks. An OFF setting will make the track disregard any incoming MIDI messages.

PERF CHANNEL selects the MIDI channel the knobs will send MIDI data on when PERFORMANCE mode is active.

AUTO CHANNEL selects the MIDI channel that will give access to the currently active track. If an external MIDI keyboard connected to Analog Rytm sends MIDI data on this channel, the keyboard will control the active track. This is useful when for example quickly changing between the active drum tracks to play different Sounds.

PROGRAM CH IN CH selects the MIDI channel that will listen for incoming program change messages. An AUTO setting will use the AUTO channel. Enable Analog Rytm to respond to program change messages in the MIDI SYNC menu, covered on page 54.

PROGRAM CH OUT CH selects the MIDI channel that will send program change messages when changing patterns. An AUTO setting will use the AUTO channel. Enable Analog Rytm to send program change messages in the MIDI SYNC menu, covered on page 54.

13.5 SYSEX DUMP

In the SYSEX DUMP menu, kits, Sounds, patterns, songs and global slots can be sent and received. Note that Sample transfer is handled exclusively via the SAMPLES menu (see above). Select a menu option using **[UP]/[DOWN]** or the LEVEL knob. Press **[YES/SAVE]** to open the highlighted menu selection.



When receiving or sending SysEx data, the MIDI ports or the USB port of Analog Rytm must be connected to the external sending/receiving device.



- If the Analog Rytm sends or receives SysEx data through the MIDI ports, use the Elektron TM-1 USB MIDI interface for up to 10x transfer speeds.
- If the external device is a computer, we recommend using our free SysEx utility C6, which can be downloaded from the Elektron website.

13.5.1 SYSEX SEND

Here kits, Sounds, patterns, songs and global slots can be sent to an external device via the MIDI OUT port or the USB port of Analog Rytm.



The column to the left selects what will be backed up. Select the column using the [LEFT] arrow key. Use the [UP]/[DOWN] keys or the LEVEL knob to scroll through the column. The SysEx data send alternatives located in the column to the right will change depending on the selection made in the left column. Press the [RIGHT] arrow key to access this column. Use the [UP]/[DOWN] keys or the LEVEL knob to select what will be sent. Press [YES/SAVE] to initiate the SysEx send procedure.

ALL offers the possibility to do complete backups of various data.

- **WHOLE PROJECT** will send all kits, Sounds, patterns, songs and global slots + settings to the receiving device. I.e. the complete project.
- **ALL SOUNDS** will send all Sounds to the receiving device.
- **ALL KITS** will send all kits to the receiving device.
- **ALL PATTERNS** will send all patterns to the receiving device.
- **ALL SONGS** will send all songs to the receiving device.
- **ALL GLOBALS** will send all global slots to the receiving device.
- **ALL SETTINGS** will send all settings to the receiving device.

KIT will send the selected kit to the receiving device. An asterisk at the end of the kit name indicates the kit is not linked to any pattern.

SOUND will send the selected Sound to the receiving device.

PATTERN will send the selected pattern to the receiving device. To the right of the pattern slot, the name of the kit linked to the pattern is visible. An asterisk indicates the pattern is not linked to a kit.

PATTERN + KIT will send the selected pattern plus its associated kit to the receiving device.

SONG will send the selected Song to the receiving device.

GLOBAL will send the selected Global slot to the receiving device.



- Backing up your data regularly is important!
- Before initiating a SysEx send, first make sure the receiving device is listening for data to be sent. If C6 is used, once transmission is complete, always check that none of the objects are broken

13.5.2 SYSEX RECEIVE

Here kits, Sounds, patterns, songs and global slots can be received from an external device via the MIDI IN port or the USB port of Analog Rytm.



The column to the left selects what will be received. Select the column using the [LEFT] arrow key. Use the [UP]/[DOWN] keys or the LEVEL knob to scroll through the column. The SysEx data receive alternatives located in the column to the right will change depending on the selection made in the left column. Press the [RIGHT] arrow key to access this column. Use the [UP]/[DOWN] keys or the LEVEL knob to select what will be received. Press [YES/SAVE] to initiate the SysEx receive procedure. Analog Rytm will start listening to incoming data. Press [NO/RELOAD] to stop listening.

ANYTHING will listen to and receive any viable SysEx data sent.

KIT will exclusively listen to and receive kit data.

- **ACTIVE KIT** will when receiving kit SysEx data replace currently active kit with the received kit.
- **KIT 01-128** will store a received kit to the selected kit slot. An asterisk at the end of the kit name indicates the kit is not linked to any pattern.

SOUND POOL will store a received Sound to the selected slot of the Sound Pool of the active project.

+DRIVE SOUND will store a received Sound to the selected slot of the +Drive Sound library. The option **ANYWHERE** will place the Sound in the first free slot available. To the right of the bank indication, the amount of free slots can be seen.

PATTERN will store a received pattern to the selected pattern slot. To the right of the pattern slot, the name of the kit linked to the pattern is visible. An asterisk indicates the pattern is not linked to a kit.

SONG will store a received song to the selected song slot.

GLOBAL will store a received global to the selected global slot.



- Initiate the SysEx send from the sending device after Analog Rytm has started listening to incoming data.
- When receiving to a specific list position, any subsequent data will be received on the next position, or positions, in the list.
- Analog Rytm can receive SysEx data at any time, regardless of the currently active menu. The data will be loaded into the position specified when it was saved, or to the first free slot if unspecified.

13.6 AUDIO ROUTING

In this menu, you can customize track routing. Use [ARROW] keys [UP] and [DOWN] to highlight one of the two options.

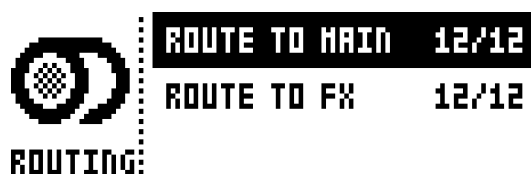

ROUTE TO MAIN highlight this option to customize which of the 12 tracks will send to the main output. Use the [PADS] to activate/deactivate send from the track of each corresponding pad. <PADS> of a green color send to main. Unlit <PADS> do not. Note that each track will still send to its individual output.

ROUTE TO FX highlight this option to customize the FX routing of the 12 tracks. Use the [PADS] to activate/deactivate each corresponding track for routing through the FX. <PADS> of a yellow color route to FX. Unlit <PADS> do not.

13.7 CONTROL

13.7.1 SEQUENCER CONFIG

Here settings relating to the sequencer can be found. Change settings by using the [LEFT]/[RIGHT] arrow keys or the [YES/SAVE] key.



QUANTIZE LIVE REC will when active quantize notes entered in LIVE RECORDING mode to complete sequencer steps. When the setting is deactivated, live recorded notes will where applicable be affected by micro timing. Read more about micro timing in the section “11.7 TRIG MENU” on page 42.

KIT RELOAD ON CHG will cause kits to reload to their saved state automatically as soon as a new kit becomes active. This is useful if you for example play live, have tweaked a kit extensively and want it to return to its saved state automatically next time it becomes active again.

AUTO TRK SWITCH will when checked, change the active track to the track whose [PAD] or [TRIG] key you last pressed. This lets you change the active track without having to use the [FUNCTION] key.

13.8 SYSTEM

The System menu contains USB CONFIG, OS UPGRADE, FORMAT +DRIVE, CALIBRATION and VERIFY FACTORY SAMPLES options for the Analog Rytm.

13.8.1 USB CONFIG

To use the Analog Rytm as an Overbridge device (see “OVERBRIDGE” on page 11), you must set it to Overbridge mode. Do so by selecting the OVERBRIDGE menu item and ticking the box by pressing [YES/SAVE].



Should you, for some reason, wish to disable the Overbridge integration functionality, select the item called USB MIDI and press [YES/SAVE].

13.8.2 OS UPGRADE

Use this menu option is used when you want to upgrade the Analog Rytm OS. To send the OS syx file, use our free Elektron Transfer software. The OS syx file and Elektron Transfer can be downloaded from the Elektron website.

For the transfer to be possible, the device sending the OS syx file must be connected to the USB port of Analog Rytm.

Please note that the Analog Rytm will not appear as an icon on your computer desktop.

1. Connect the Elektron device to the computer via USB.
2. Open the Transfer application on your computer.
3. On the Transfer CONNECTIONS page, set the MIDI IN and MIDI OUT ports to your Elektron device.
4. On the Transfer DROP page, drag and drop the OS file. The OS file is then automatically transferred to the Elektron device and the OS update initiates. A progress bar is visible on device screen when receiving the OS.
5. On your device. Press [YES] to confirm the OS update.

When the process is successfully completed, the OS is updated and the unit reboots.

13.8.3 FORMAT +DRIVE

You have the possibility to erase all content of the +Drive. Once you have made your choices using the [LEFT] or [RIGHT] arrow keys and confirmed by pressing [YES/SAVE], a prompt will appear asking if the formatting procedure should be executed. Press [YES/SAVE] to proceed with the formatting.



PROJECTS+SOUNDS Erases all projects and Sounds. Tick/untick this box by pressing the [LEFT] or [RIGHT] arrow keys.

SAMPLES Erases all samples. Tick/untick this box by pressing the [LEFT] or [RIGHT] arrow keys.

13.8.4 CALIBRATION

The Analog Rytm calibration routine is found here.

Calibration will start the calibration routine for the oscillators and filters. After selecting this option, a popup window asking to confirm the calibration will appear. Press **[YES/SAVE]** to proceed with the calibration. Please note that the calibration routine takes quite a while to complete.

Please note that during calibration there will be loud and unpleasant sounds on the individual outs. Disconnect these during calibration.



Analog Rytm is factory calibrated. It should not be re-calibrated unless specifically stated by Elektron Support or if prompted by the machine. Before calibrating, it is important that the unit has been turned on for at least two hours to attain working temperature.

13.8.5 VERIFY FACTORY SAMPLES

Activating this will start a verification routine that checks if the factory samples are in the right place.

A factory reset is needed if the result turns out to be negative, For more information, please see “14. STARTUP MENU” on page 62.

14. STARTUP MENU

To access this menu, hold down the [FUNCTION] key while powering up Analog Rytm. From here you can perform a variety of tasks. To choose the different alternatives, press the corresponding [TRIG] key.

```

RYTM MENU
1 ... TEST MODE
2 ... EMPTY RESET
3 ... FACTORY RESET
4 ... OS UPGRADE

```

14.1 TEST MODE

To enter this mode, press the first [TRIG] key.



Warning: For testing purposes, a short loud beep is heard through all outputs of the unit.

If you have any trouble with your Analog Rytm and suspect it may be due to a hardware problem, perform this self-test. No errors should be reported as shown below. If that is not the case, contact Elektron support or the retailer that you bought Analog Rytm from. The [UP] and [DOWN] keys can be used to scroll through the test log.

```

TEST MODE
0 ERRORS
UI:[+]
NVRAM:[+]

```

14.2 EMPTY RESET

To perform this operation, press the second [TRIG] key. All kits, patterns, Sounds and songs will be erased. The +Drive remains intact.

14.3 FACTORY RESET

When performing a factory reset on the Analog Rytm, it will overwrite and re-initialize the active RAM project (including all pattern, kit, sound pool and global data). The +Drive project slot 1 will be overwritten and re-initialized with factory preset patterns, kits, Sounds and settings. Sound bank A will be overwritten with the factory Sounds.

If you wish to keep the active project, remember to save it to a +Drive project slot higher than 1 before you perform a factory reset. To perform a factory reset, press the third [TRIG] key.



When you are in the STARTUP menu, you also have the possibility to perform a total reformatting of the +Drive and at the same time perform a factory reset. Please keep in mind that it will empty the +Drive of all your presets and patterns and reset it to the factory content only. To reformat the +Drive and make a factory reset, press [SONG] + [CHAIN] + [TRIG 3].

14.4 OS UPGRADE

Initiate the OS upgrade by pressing the fourth [TRIG] key. Use this menu option if you for some reason cant upgrade the Analog Rytm OS using the standard procedure in the SYSTEM menu. To send the OS file, use our free Elektron Transfer software. The Elektron Transfer can be downloaded from the Elektron website.

1. Download the Analog Rytm OS file from the Elektron website.
2. Connect the Analog Rytm's MIDI IN port to the MIDI OUT port of the computer's MIDI interface.
3. Hold down the [FUNC] key while powering on Analog Rytm. This takes you to the STARTUP menu.
4. Press the [TRIG 4] key to enter OS UPGRADE mode.
5. Open the Transfer application on your computer. On the Transfer CONNECTION page, click "go to the SYSEX TRANSFER page".

6. On the SYSEX TRANSFER page, click “OS Upgrade via device startup menu”, and then follow the on-screen instructions.

When the update is done, the Analog Rytm will reboot.



USB MIDI transfer is not possible when upgrading the OS from the STARTUP menu.

15. SETUP EXAMPLES

The Analog Rytm likes to play with other machines. Whether it uses its ability to sync and play with legacy machines, plays its part among other Elektron machines or plays with incoming audio: Analog Rytm gets along with other gear. Three examples are shown here.

15.1 ANALOG RYTM WITH A MONOPHONIC BASS MACHINE

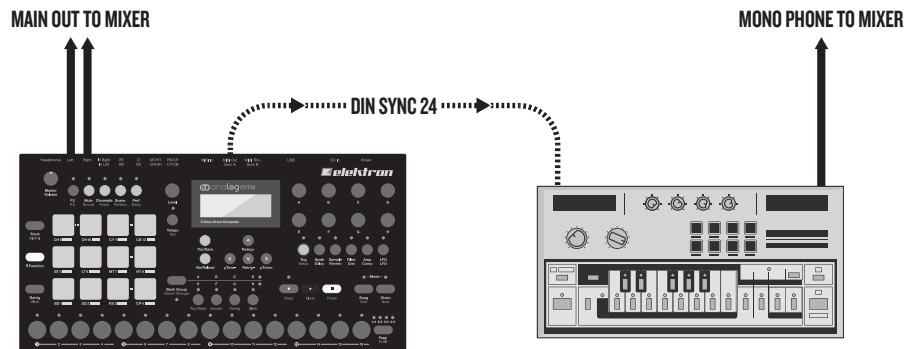

The DIN sync capabilities of the Analog Rytm allows you to use gear from times gone by.

In this example, a legacy monophonic bass machine is used alongside the Analog Rytm. The bass machine bassline is started, stopped and tempo controlled with the Analog Rytm.

1. Prepare a bassline pattern on the bass machine.
2. Connect the output of the bass machine to the mixer using a standard phone cable.
3. Connect the Analog Rytm outputs to the mixer using standard phone cables.
4. Connect the MIDI Out of the Analog Rytm to the SYNC IN of the bass machine using a DIN connector.
5. On the MIDI PORT CONFIGURATION menu, in the GLOBAL menu of the Analog Rytm, use the setting DIN24 on the OUT PORT FUNCTIONALITY selector.



6. Prepare a rhythm on the Analog Rytm.

15.2 ANALOG RYTM WITH OTHER ELEKTRON GEAR

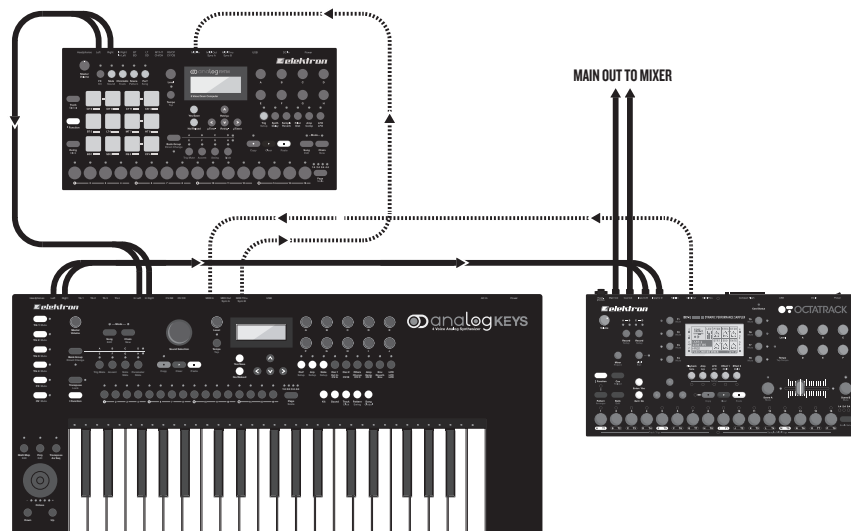

Analog Rytm gets along with other broods of the Elektron breed. Here, it is used with an Octatrack and an Analog Keys.

In this example, the Analog Rytm creates the beats. The Analog Keys is used for bass and synth sounds. The Octatrack plays back loops and samples the audio from the Analog Rytm and the Analog Keys.

1. Connect the Analog Rytm main outputs to the Analog Keys inputs, the Analog Keys main outputs to one of the input pairs of the Octatrack, and the main outputs of the Octatrack to the PA. Use standard phone connectors.
2. Make sure the Analog machines are MIDI slaved to the Octatrack using two standard MIDI cables.
3. On the MIDI configuration menu, found in the GLOBAL menu on the Analog Rytm, ensure the MIDI SYNC has CLOCK RECEIVE, and PROG CH RECEIVE activated.



4. On the MIDI PORT CONFIGURATION menu, also in the GLOBAL menu, use the setting MIDI or MIDI+USB for the input port.



5. Use the internal effects of the Analog Keys on the incoming signal from the Analog Rytm. Make a performance macro on the Analog Keys controlling the desired FX parameters.

15.3 ANALOG RYTM WITH A STEREO PHONIC DRUM MACHINE

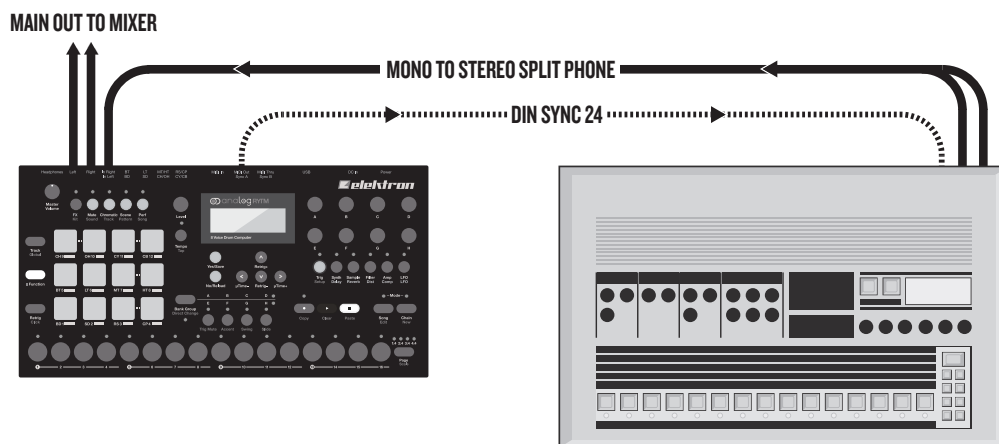

Use the Analog Rytm compressor when you incorporate sounds from external instruments in your composition.

The following example shows how an old drum machine is hooked up to the Analog Rytm. The stereo output from the drum machine can be compressed to fit in nicely, and its patterns started, stopped and tempo controlled, using the Analog Rytm.

1. Prepare a rhythm pattern on your heritage drum machine.
2. Connect the stereo outputs of the drum machine to the inputs of the Analog Rytm using a mono to stereo split phone cord.
3. Connect the MIDI Out of the Analog Rytm to the SYNC of the drum machine.

15. SETUP EXAMPLES

4. On the MIDI PORT CONFIGURATION menu, in the GLOBAL menu of the Analog Rytm, use the setting DIN24 on the OUT PORT FUNCTIONALITY selector.



5. Start the rhythm on the drum machine and access the COMPRESSOR of the Analog Rytm by pressing the [FX] key, then the fourth [PARAMETER] key. Set the parameters according to taste.



6. Prepare a rhythm on the Analog Rytm.

16. USEFUL KEY COMBINATIONS (QUICK KEYS)

Use the key combinations below to quickly perform certain tasks.

GENERAL

[FUNCTION] + [REC] will perform a copy command. Action depends on the currently active page or mode.

[FUNCTION] + [PLAY] will perform a clear command. Action depends on the currently active page or mode.

[FUNCTION] + [STOP] will perform a paste command. Action depends on the content that was copied.

NAMING

[FUNCTION] + [ARROW] (on the NAMING screen) to choose a letter.

[FUNCTION] + [NO/RELOAD] (on the NAMING screen) to erase a letter.

ASSIGN SYNTH / SAMPLE

Double-tap [SYNTH] to access MACHINE (Synth engine) selection.

Double-tap [SAMPLE] to access SAMPLE selection (from the 127 user samples of the active Kit).

When SAMPLE selection is open, pick a slot and press [FUNCTION] + [YES/SAVE] to access +Drive samples.

SAVING AND RELOADING

[YES/SAVE] + [FX] will save Kit.

[NO/RELOAD] + [FX] will reload Kit.

[YES/SAVE] + [MUTE] will save Sound.

[NO/RELOAD] + [MUTE] will reload Sound.

[YES/SAVE] + [SCENE] will save Pattern.

[NO/RELOAD] + [SCENE] will reload Pattern.

[YES/SAVE] + [CHROMATIC] will save Track.

[NO/RELOAD] + [CHROMATIC] will reload Track.

[YES/SAVE] + [PERF] will save Song.

[NO/RELOAD] + [PERF] will reload Song.

MENU ACCESS

[FUNCTION] + [TRACK] to open the GLOBAL menu.

[FUNCTION] + [FX] to open the KIT menu.

[FUNCTION] + [MUTE] to open the SOUND menu.

SEQUENCER SETTINGS

[FUNCTION] + [TEMPO] to tap tempo.

[FUNCTION] + [RETRIG] to access the CLICK TRACK settings.

[FUNCTION] + [TRIG SETUP] to access the QUANTIZE settings.

[FUNCTION] + [PAGE] to access the pattern / track SCALE settings.

MUTES AND SOLO

[FUNCTION] + [PADS] will mute/unmute one or several Tracks (activate by releasing [FUNCTION]).

[RETRIG] + [PADS] to solo enable Track (multiple Tracks may be solo:ed).

SEQUENCER RECORDING

[RECORD] + [PLAY] to start LIVE RECORDING.

[RECORD] + double-tap [PLAY] will activate/deactivate QUANTIZE LIVE RECORDING.

[NO/RELOAD] + one of the [PADS] during LIVE RECORDING to clear the trigs from a sequencer track.

CLEAR TRACK / CLEAR PATTERN

[FUNCTION] + [PLAY] (while in GRID RECORDING mode) to clear active Track.

[FUNCTION] + [PLAY] (while in no mode or LIVE RECORDING mode) to clear Pattern.

SHIFTING TRIGS AROUND

[FUNCTION] + [LEFT/RIGHT] to move all trigs a whole step, left or right.

[TRIG] + [LEFT/RIGHT] to nudge a single trig a fractional step left or right.

[TRIG] + [UP/DOWN] to activate RETRIG and set retrig rate (while in GRID RECORDING mode).

CHAIN EDITING

[FUNCTION] + [CHAIN] to create new scratch pad row.

[CHAIN] + [LEFT/RIGHT] to move chain cursor.

[CHAIN] + [NO/RELOAD] to remove Pattern from the chain before cursor (or selected).

[BANK X/X] + [TRIG] to enter a new Pattern into the chain (positioned where the cursor is at).

RANDOMIZE PARAMETERS

[PARAMETER] key + [YES] to randomize all parameters on a specific parameter page.

[PARAMETER] key + [NO] to reset the PARAMETER page to its last saved state.

TRIG PREVIEW

[TRIG] + [YES] (In GRID- and STEP RECORDING mode) previews the selected trig.

17. TECHNICAL INFORMATION

SPECIFICATIONS

THE SEQUENCER

12 drum tracks
1 FX track
Up to 64 steps per pattern
Individual track lengths
12 Scenes (per kit)
Trig mute, Accent, swing and slide functions
Micro timing
Parameter locks
Chromatic mode
Scene mode
Performance mode
Versatile and assignable Retrigger
Live friendly Performance mode
Sound per step change
Instant kit, pattern and Sound reload
Full real-time control

STORAGE

128 projects (+Drive)
128 Kits (per project)
128 patterns (per project)
16 Songs (per project)
128 Sounds (per project)
4096 sounds (+Drive Sound library)
127 user samples (per project)
1 GB sample memory capacity

MASTER EFFECTS

Analog Stereo Distortion
Analog Stereo Compressor

SEND EFFECTS

Delay
Reverb

8 x DRUM VOICE

Fully analog signal path
1 x analog percussion sound generator
1 x analog overdrive circuit
1 x 2-pole analog multi-mode filter
1 x analog stereo VCA
1 x filter envelope
1 x amp envelope
2 x effect sends
1 x assignable LFO
1 x dedicated LFO fade envelope
1 x 16-bit sample playback engine
1 x sample bitrate reduction

ELECTRICAL SPECIFICATIONS

Impedance balanced audio outputs:
Main outputs level: +15 dBu
Output impedance: 440 unbalanced
Headphones output:
Headphones out level: +15 dBu
Output impedance: 55
Unbalanced audio inputs:

17. TECHNICAL INFORMATION

Input level: +15 dBu maximum

Audio input impedance: 9 k

Individual Outputs:

Output level: +15 dBu

Output Impedance: 440

Unit power consumption: 14 W typical, 20 W maximum.

Recommended power supply: PSU-3/b/c, 12V DC, 2A

HARDWARE

12 synthetic rubber, pressure sensitive, backlit pads

122x32 pixel backlit LCD screen

MIDI In/Out/Thru with DIN Sync out

2 x 1/4" impedance balanced audio out jacks

1 x 1/4" stereo audio in jack

1 x 1/4" stereo headphone jack

4 x 1/4" (TRS) paired individual track output jacks

48 kHz, 24-bit D/A and A/D converters

Flash-EEPROM upgradable operating system

Electrically isolated multi-functional USB 2.0 port

PHYSICAL SPECIFICATIONS

Sturdy steel casing

Dimensions: W 340 x D 176 x H 63mm (13.4" x 6.9" x 2.5") (including power switch, knobs and feet)

Weight: approximately 2.4 kg (5.3 lbs)

18. CREDITS AND CONTACT INFORMATION

18.1 CREDITS

PRODUCT DESIGN AND DEVELOPMENT

Oscar Albinsson
Magnus Forsell
Anders Gärder
Jimmy Myhrman
Jon Mårtensson
David Revelj
Mattias Rickardsson
Daniel Troberg

ADDITIONAL DESIGN

Ufuk Demir
Thomas Ekelund

FACTORY DEFAULT SOUND DESIGN

Linus Andersson
Ufuk Demir
Thomas Ekelund
Per Engström
Antony Klæboe
Filip Leyman
Andreas Lundin
Jimmy Myhrman
Jon Mårtensson
Olle Petersson
Johan Reivén
Cenk Sayinli
Charlie Storm
Daniel Troberg

DOCUMENTATION

Ufuk Demir
Thomas Ekelund
Jon Mårtensson
Daniel Sterner
Erik Ångman

18.2 CONTACT INFORMATION

ELEKTRON WEBSITE

<http://www.elektron.se>

OFFICE ADDRESS

Elektron Music Machines MAV AB
Banehagsliden 5
SE-414 51 Gothenburg
Sweden

APPENDIX A: DRUM TRACK PARAMETERS

This appendix lists the parameters on the five PARAMETER pages for the drum tracks and explains them. With one significant exception, each unique page contains the same parameters on all drum tracks. The exception is the SYNTH page, where parameters will vary depending on the active MACHINE.



- You can randomize the parameter settings on a specific PARAMETER page of a track. Press [PARAMETER] key + [YES] to randomize all parameters on that page. Every time you press this key combination, the parameters randomize in a new way.
- Press [PARAMETER] key + [NO] to reset the PARAMETER page to its last saved state.
- The parameters on the TRIG page can not be randomized.

A.1 SYNTH

Controls the (analog and digital) sound synthesis. The parameters for the BD track with the BDHD machine are shown here. For the SYNTH pages of other machines, see “APPENDIX D: MACHINES” on page 89.

SYNTH (BDHD)



TUN (Tune) sets the pitch of the voltage controlled oscillator in chromatic semitones. (-64+63)

SWT (Sweep Time) sets the pitch sweep time. Low values result in a short sweep, while high values result in a long sweep. (0-127)

SNP (Snap Amount) sets the amount of snap, an immediate pitch sweep at the start of the sound attack phase. Use together with TIC to shape the transient sound components. (0-127)

DEC (Decay) sets the length of the decay phase. Low values mean a steep, quick decay while high values produce a more gentle slope and a sound of longer duration. (0-127)

WAV (Waveform) sets the voltage controlled oscillator waveform to sine, asymmetric sine or triangle. The three waveforms, in that order, produce sounds with increasing amounts of overtone content. (0, 1 or 2).

HLD (Hold) sets the length of the hold phase before the decay phase kicks in. Low values correspond to short hold time, high values correspond to longer hold time. Use to shape the body of the drum sound. (0-127)

TIC (Tick Level) sets the level of the transient tick sound. Use together with SNP to shape the composite transient sound. (0-127)

LEV (Level) sets the volume of the SYNTH sound. (0-127)

A.2 SAMPLE

The parameters on this page control the playback of the user samples. A project has 127 user sample slots. Within each kit, these samples may be dynamically allocated, modulated and customized.

SAMPLE

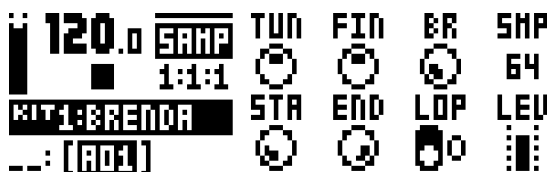

TUN (Tune) sets the pitch of the sample in equivalents of chromatic semitones. To move faster, press the knob while turning it. The knob works in a bipolar fashion, with 0, north, leaving the pitch unchanged. Range (-24+24), equivalent to four octaves.

FIN (Fine Tune) fine tunes the pitch of the sample. This parameter is an offset from the TUN parameter. The knob works in a bipolar fashion. The whole range (-64+63) spans one semitone down and one semitone up.

BR (Bit Reduction) increasing the value of this parameter decreases the resolution of the sample, making it more grainy. Use when you want the sound of your drum sample to punch dirty like the sound effects of classic coin-op fighting games. (0–127)

SMP (Sample Slot) turn this knob to browse the list of up to 127 samples loaded into the project. Turn the knob clockwise to scroll down the list, counter-clockwise to scroll up. The first position, OFF, plays no sample at all (OFF, 1–127).

STA (Start) sets the starting point for the playback of the sample. The extreme values of the range (0–120) are the very beginning and the very end of the sample, respectively. This is a codependent parameter and must be set together with END.

END (End) sets the end point for the playback of the sample. The extreme values of the range (0–120) are the very beginning and the very end of the sample, respectively. If the value of END is lower than the value of STA, the sample will be played back backward.

LOP (Loop) when OFF, the sample will be played back once every time it is triggered. When ON, the sample will loop continuously for the length of the trig (set with LEN on the TRIG page), confined by the AMP page envelope parameter settings HLD and DEC. (1/0 - ON/OFF).

LEV (Level) sets the volume of the sample. (0–127)

A.3 FILTER

On the FILTER page you will find all parameters that control the analog multimode filter and its associated envelope.

FILTER

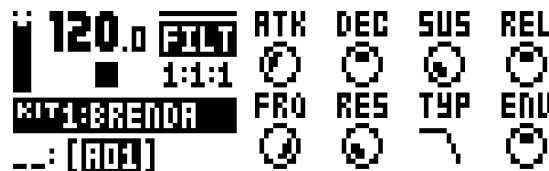

ATK (Attack) sets the length of the attack phase of the filter envelope. (0–127)

DEC (Decay) sets the length of the decay of the filter envelope. (0–127)

SUS (Sustain Level) sets the sustain level of the filter envelope. (0–127)

REL (Release) sets the length of the release phase of the filter envelope. (0–127)

FRQ (Frequency) sets the cutoff frequency of the multimode filter. (0–127)

RES (Resonance) sets the resonance behavior of the filter. Resonance introduces a peak in the spectrum at the cutoff frequency. With the Bandstop filter type, there is a notch instead of a peak. The notch will be at its widest at the lowest Resonance setting. (0–127)

TYP (Filter Type) selects the filter type. Seven types are available: 2-pole Lowpass, 1-pole Lowpass, Bandpass, 1-pole Highpass, 2-pole Highpass, Bandstop, and Peak. Technically all of them are resonant 2-pole filters, but the 1-pole types have a flatter spectrum like simple 1-pole filters and are convenient for equalizer duties.

ENV (Envelope Depth) sets the depth of modulation within the filter envelope. The knob is bipolar, meaning that both negative and positive modulation depth is available. Range (-64–+63)

A.4 AMP

The AMP page controls parameters for the amplitude envelope, overdrive, effects sends, panning and volume.

AMP



ATK (Attack) sets the length of the attack phase of the amp envelope. (0–127)

HLD (Hold) sets the length of the hold phase of the amp envelope before the decay phase kicks in. Range (AUTO, 1-127). The AUTO setting means the hold phase is determined by the time the pad of the drum track is physically pressed. Values in the range (1-127) fix the hold phase, from very short times at the left extreme to increasingly long times to the right, regardless of how long the pad is pressed.

DEC (Decay) sets the length of the decay phase of the amp envelope. (0-INF)

OVR (Overdrive) sets the overdrive (gain increase boost of the amp), located before the multimode filter in the signal path. Take care not to harm your hearing when using the overdrive, and also not to over-use it when crafting a Sound (as it is a bit of a rock'n'roll cliché to go heavy on the overdrive). (0-127)

DEL (Delay Send) sets the amount of the Sound that will be sent through to the Delay effect (see "APPENDIX B: FX TRACK PARAMETERS" on page 75). (0-127)

REV (Reverb Send) sets the amount of the Sound that will be sent through to the Reverb effect (see Appendix B). (0-127)

PAN (Pan) positions the Sound in the stereo field. The knob function is bipolar with 0 being the perfectly balanced midpoint, -64 sending all sound to the left channel and +63 sending all sound to the right.

VOL (Volume) sets the volume of amplification of the Sound. This parameter is independent of the overall track level. (0-127)

A.5 LFO

The LFO can be used to interfere creatively with any parameter found on the SYNTH, SAMPLE, FILTER and AMP pages. Customize the low-frequency oscillator behavior, orientation, and depth on this page.

LFO



SPD (Speed) sets the speed of the LFO. For the LFO to be synced to straight beats, try settings of 8, 16 or 32. The knob is bi-polar. The LFO cycle can be played backward by using negative values. (-64+63)

MUL (Multiplier) multiplies the SPD parameter by the set factor. (x) multiplies the current tempo, (dot) syncs the LFO to 120 BPM regardless of the tempo. 24 settings: (12 tempo synced, 12 free).

FAD (Fade In/Out) makes it possible to fade in/fade out the LFO modulation. The knob is bipolar. Positive values give a fade-out, negative values give a fade-in. A mid position (0) will result in no fade in/fade out. (-64+63)

DST (Destination) selects the destination for the LFO. A list will appear when you turn the knob. Choose a parameter from any of the parameter pages. Turn the knob clockwise to go down the list, counter-clockwise to go up. Preview how the LFO modulation will affect the sound by highlighting a destination. Confirm a selection by pressing [YES/SAVE].

WAV (Waveform) sets the LFO waveform. There are seven waveforms: Triangle, Sine, Square, Sawtooth, Exponential, Ramp and Random.

SPH (Start Phase) sets the LFO cycle start position when it is triggered. Range (0-127). 0 is the start of a complete wave cycle and 127 is the end point. 64 is the dead center.

MOD (Trig Mode) sets how the LFO will act when a note is triggered. Five settings exist.

- **FRE** is the default free-running mode. It makes the LFO run continuously, never restarting or stopping.
- **TRG** makes the LFO restart when a note is triggered.
- **HLD** makes the LFO run free in the background, but when a note is triggered the LFO output level is latched and held still until the next note is triggered.
- **ONE** The LFO starts when a note is triggered, then runs to the end of the waveform and then stops. This makes the LFO function similar to an envelope.
- **HLF** The LFO starts when a note is triggered, then runs to the middle of the waveform and then stops.

DEP (Depth) sets the depth and polar orientation of the LFO modulation. Both negative (inverted) and positive modulation depth is possible. Positive values start the oscillation toward the crest phase of the wave, negative values start toward the trough phase of the wave. A dead center setting, 0, equals no modulation depth at all. (-128+127)

APPENDIX B: FX TRACK PARAMETERS

In this appendix, the parameters of the FX track are shown and explained, one page at a time.

B.1 DELAY

The Delay send effect takes a duplicate of the input signal, delays it in time and then rejoins it with the original signal. Customize the delay parameters on this page.

DELAY

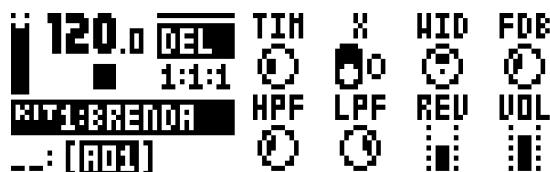

TIM (Delay Time) sets the delay time. It is relative to the current BPM and is measured in 128th notes. For instance, a setting of 32 equals a one beat delay (four sixteenth notes). (1–128)

X (Pingpong) sets the delay signal to alternate across the stereo field. There are two settings:

- **0** (off) if you wish to manually set the position of the delay signal in the stereo field instead. Do so using the WID parameter.
- **1** (on) makes the delay signal alternate between left and right pan positions. The WID parameter controls the amount of panning.

WID (Stereo Width) sets the delay signal pan width across the stereo field. The knob is bipolar. (-64–+63)

FDB (Feedback) sets the amount of delay output signal to feed back into the input of the delay. With higher parameter settings, infinite and/or swelling delays are possible to achieve. Please be aware that high feedback can lead to a very loud signal, and that the DOV parameter on the DISTORTION page can further increase the harshness of the feedback. (1–198)



HPF (HP Filter) sets the cutoff frequency of the delay highpass filter. (0–127)

LPF (LP Filter) sets the cutoff frequency of the delay lowpass filter. (0–127)

REV (Reverb Send) sets the amount of Delay output signal to be sent to the Reverb. (0–127)

VOL (Mix Volume) adjusts the volume of the Delay output signal. The output is routed either before or after the Distortion and Compressor effects, depending on the setting of the DEL parameter on the DISTORTION page. (0–127)

B.2 REVERB

The Reverb send effect controls the persistence, and ambient characteristics, of the sound reverberations. It can simulate many different sonic locations, from great spaces to small confinements.

REVERB



PRE (Pre-delay) sets the pre-delay time of the Reverb. (0–127)

DEC (Decay) sets the length of the decay phase of the reverberated signal, essentially setting the size of the acoustic space. (1–INF)

FRQ (Shelving Frequency) sets the shelving filter frequency. Together with the GAI parameter, it can be used to dampen the reverberated signal above a chosen frequency, making the reverberation sound more poignant or more muffled. (0–127)

GAI (Shelving Gain) affects the damping of the reverberated signal above the shelving frequency set by the FRQ parameter. At max value the treble is included in the reverberations; lowering the value gradually dampens it. (0–127)

HPF (HP Filter) sets the cutoff frequency of the reverb high-pass filter. (0–127)

LPF (LP Filter) sets the cutoff frequency of the reverb low-pass filter. (0–127)

VOL (Mix Volume) sets the volume of the Reverb output signal. The output is routed either before or after the Distortion and Compressor effects, depending on the setting of the REV parameter on the DISTORTION page. (0–127)

B.3 DISTORTION

The distortion master effect pronounces the peaks of the signal and distorts them. Additionally, the sound may be offset in its entirety on this page and subjected to non-symmetrical distortion. This page also controls the overdrive of the Delay effect, as well as the routing of the Delay and Reverb effect returns.

DIST

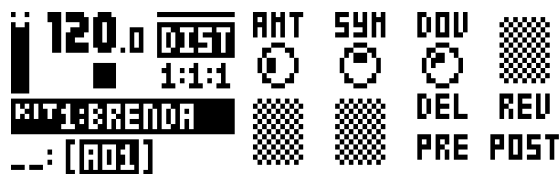

AMT (Distortion Amount) sets the amount of distortion applied to the signal. (0–127)

SYM (Distortion Symmetry) offsets the whole signal (in the y direction, if visualized as a wave cycle on a 2D graph) either up (positive values) or down (negative values) before applying distortion. This makes asymmetric distortion of the signal possible, fringing only the crests or the troughs of the wave. (-64–+63)

DOV (Delay Overdrive) sets the overdrive of the Delay effect, for a warm, dynamic distortion of the signal. Set this in conjunction with the FDB parameter on the DELAY page to produce anything from a tinge of shear to a very aggressive four-pound barrage of overtones. (0–127)

DEL (Delay Dist/Comp) sets the Delay effect to return before (0) or after (1) the signal is subject to distortion and compression. The default setting is before. (0/1)

REV (Reverb Dist/Comp) sets the Reverb effect to return before (0) or after (1) the signal is subject to distortion and compression. The default setting is after. (0/1)

B.4 COMPRESSOR

The Compressor master effect compresses the dynamic range of the signal by reducing the volume of loud sounds relative to the quiet sounds. There are eight parameters with which the compressor is customized on this page.

COMP

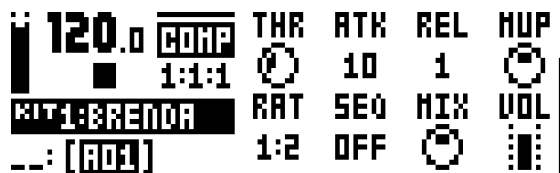

THR (Threshold) sets the threshold of the compressor. A lower threshold means a larger portion of the signal will be subject to compression. There is a bar on the rightmost edge of the LCD screen which will visually represent the amount of compression. (0–127)

ATK (Attack) sets the time of the compressor attack phase, i.e. how quickly the compressor responds to loud peaks. The time of the attack phase is set in milliseconds. (0.03–30)

REL (Release) sets the time of the compressor release phase, i.e. how long it takes for the compression to recover in quieter moments. The time is set in seconds. Range (0.1–2, A1 or A2). A1 and A2 are two types of auto release phases, (A2) being slightly longer than (A1).

MUP (Makeup Gain) sets the makeup gain of the compressor output, to compensate for the reduced signal levels caused by compression. (0–127)

RAT (Compression Ratio) There are four different compression ratios, 1:2, 1:4, 1:8 and MAX. Higher ratios result in greater compression of the signal.

SEQ (Sidechain EQ) filters the signal before it is analyzed by the compressor in one of the following ways:

- **OFF** lets the sidechain signal remain unchanged.
- **LPF** lowpass filters the signal before analysis, making the compressor react mostly to the bass. Use this setting for a characteristic pumping compressor sound.
- **HPF** passes the signal through a highpass filter before it is analyzed, making the compressor react less to the bass. Use this setting to avoid pumping.
- **HIT** results in a balanced equalization of the sidechain signal, making the compressor react similarly to all frequencies of the signal.

MIX (Dry/Wet Mix) sets the mix of the uncompressed signal and the compressor output signal. The left extreme setting results in a completely uncompressed signal. The extreme right setting lets only the compressed signal pass through. All values in between mix the uncompressed signal with the compressed signal, also known as parallel compression. A definitive Motown compression effect may be achieved at moderate MIX settings combined with high RAT and low MUP settings. (0–127)

VOL (Volume) sets the volume of the output signal. (0–127)

B.5 FX LFO

The FX track LFO page parameters are shown and explained below.

LFO1 (page 1)



SPD (Speed) sets the speed of the LFO. For the LFO to be synced to straight beats, try settings of 8, 16 or 32. The knob is bi-polar. The LFO cycle can be played backward by using negative values. (-64–+63)

MUL (Multiplier) multiplies the SPD parameter by the set factor. (x) multiplies the current tempo, (dot) syncs the LFO to 120 BPM regardless of the tempo. 24 settings: (12 tempo synced, 12 free).

FAD (Fade In/Out) makes it possible to fade in/fade out the LFO modulation. The knob is bipolar. Positive values give a fade-out, negative values give a fade-in. A mid position (0) will result in no fade in/fade out. (-64–+63)

DST (Destination) selects the destination for the LFO. A list will appear when you turn the knob. Choose a parameter from any of the parameter pages. Turn the knob clockwise to go down the list, counter-clockwise to go up. Preview how the LFO modulation will affect the sound by highlighting a destination. Confirm a selection by pressing [YES/SAVE].

WAV (Waveform) sets the LFO waveform. There are seven waveforms: Triangle, Sine, Square, Sawtooth, Exponential, Ramp and Random.

SPH (Start Phase) sets the wave phase where the LFO will start when it is triggered. (0–127) 0 is the start of a complete wave cycle, and 127 is the end point. 64 is the dead center.

MOD (Trig Mode) sets how the LFO will act when a note is triggered. Five settings exist.

- **FRE** is the default free-running mode. It makes the LFO run continuously, never restarting or stopping.
- **TRG** makes the LFO restart when a note is triggered.
- **HLD** makes the LFO run free in the background, but when a note is triggered the LFO output level is latched and held still until the next note is triggered.
- **ONE** The LFO starts when a note is triggered, then runs to the end of the waveform and then stops. This makes the LFO function similar to an envelope.
- **HLF** The LFO starts when a note is triggered, then runs to the middle of the waveform and then stops.

DEP (Depth) sets the depth and polar orientation of the LFO modulation. Both negative (inverted) and positive modulation depth is possible. Positive values start the oscillation toward the crest phase of the wave. Negative values start toward the trough phase of the wave. A dead center setting, 0, equals no modulation depth at all. (-128–+127)

APPENDIX C: MIDI

This appendix lists the CC and NRPN specification for the Analog Rytm.

C.1 GENERAL TRIG PARAMETERS

TRIG PARAMETERS				
Parameter	CC MSB	CC LSB	NRPN MSB	NRPN LSB
Note	3		3	0
Velocity	4		3	1
Length	5		3	2
Synth Trig	11		3	3
Sample Trig	12		3	4
ENV Trig	13		3	5
LFO TRIG	14		3	6

C.2 GENERAL KIT PARAMETERS

COMMON				
Parameter	CC MSB	CC LSB	NRPN MSB	NRPN LSB
Track Level	95		1	100
Track Mute (seq. mute)	94		1	101
Track Solo (seq. mute)	93		1	102
Track Machine Type	15		1	103
Active Scene	92		1	104

C.3 PERFORMANCE PARAMETERS

PERFORMANCE				
Parameter	CC MSB	CC LSB	NRPN MSB	NRPN LSB
Performance Parameter 1	35		0	0
Performance Parameter 2	36		0	1
Performance Parameter 3	37		0	2
Performance Parameter 4	39		0	3
Performance Parameter 5	40		0	4
Performance Parameter 6	41		0	5
Performance Parameter 7	42		0	6
Performance Parameter 8	43		0	7
Performance Parameter 9	44		0	8
Performance Parameter 10	45		0	9
Performance Parameter 11	46		0	10
Performance Parameter 12	47		0	11

C.4 GENERAL SYNTH PARAMETERS

Note that the order of the SYNTH parameters below will sometimes differ from the order of the parameters shown on the SYNTH page of the RYTM. See the section MACHINE PARAMETERS below for a more detailed list.

SYNTH				
Parameter	CC MSB	CC LSB	NRPN MSB	NRPN LSB
Synth Parameter 1	16		1	0
Synth Parameter 2	17		1	1

SYNTH				
Parameter	CC MSB	CC LSB	NRPN MSB	NRPN LSB
Synth Parameter 3	18		1	2
Synth Parameter 4	19		1	3
Synth Parameter 5	20		1	4
Synth Parameter 6	21		1	5
Synth Parameter 7	22		1	6
Synth Parameter 8	23		1	7

SAMPLE				
Parameter	CC MSB	CC LSB	NRPN MSB	NRPN LSB
Sample Tune	24		1	8
Sample Finetune	25		1	9
Sample Bit Reduction	26		1	10
Sample Slot	27		1	11
Sample Start	28		1	12
Sample End	29		1	13
Sample Loop	30		1	14
Sample Level	31		1	15

FILTER				
Parameter	CC MSB	CC LSB	NRPN MSB	NRPN LSB
Filter Attack Time	70		1	16
Filter Decay Time	71		1	17
Filter Sustain Level	72		1	18
Filter Release Time	73		1	19
Filter Frequency	74		1	20
Filter Resonance	75		1	21
Filter Mode	76		1	22
Filter Env Depth	77		1	23

AMP				
Parameter	CC MSB	CC LSB	NRPN MSB	NRPN LSB
Amp Attack Time	78		1	24
Amp Hold Time	79		1	25
Amp Decay Time	80		1	26
Amp Overdrive	81		1	27
Amp Delay Send	82		1	28
Amp Reverb Send	83		1	29
Amp Pan	10		1	30
Amp Volume	7		1	31

C.5 LFO PARAMETERS

Note that the LFO depth is a high-resolution parameter, with CC LSB value.

LFO				
Parameter	CC MSB	CC LSB	NRPN MSB	NRPN LSB
LFO Speed	102		1	32
LFO Multiplier	103		1	33
LFO Fade In/Out	104		1	34
LFO Destination	105		1	35
LFO Waveform	106		1	36
LFO Start Phase	107		1	37
LFO Trig Mode	108		1	38
LFO Depth	109	118	1	39

C.6 FX PARAMETERS

DELAY				
Parameter	CC MSB	CC LSB	NRPN MSB	NRPN LSB
Delay Time	16		2	0
Delay Pingpong	17		2	1
Delay Stereo Width	18		2	2
Delay Feedback	19		2	3
Delay Highpass Filter	20		2	4
Delay Lowpass Filter	21		2	5
Delay Reverb Send	22		2	6
Delay Mix Volume	23		2	7

REVERB				
Parameter	CC MSB	CC LSB	NRPN MSB	NRPN LSB
Reverb Predelay	24		2	8
Reverb Decay Time	25		2	9
Reverb Shelving Freq	26		2	10
Reverb Shelving Gain	27		2	11
Reverb Highpass Filter	28		2	12
Reverb Lowpass Filter	29		2	13
Reverb Mix Volume	31		2	15

DISTORTION				
Parameter	CC MSB	CC LSB	NRPN MSB	NRPN LSB
Dist Amount	70		2	16
Dist Symmetry	71		2	17
Delay Overdrive	72		2	18
Delay Dist/Comp Routing (pre/post)	76		2	22
Reverb Dist/Comp Routing (pre/post)	77		2	23

COMPRESSOR				
Parameter	CC MSB	CC LSB	NRPN MSB	NRPN LSB
Compressor Threshold	78		2	24
Compressor Attack Time	79		2	25
Compressor Release Time	80		2	26
Compressor Makeup Gain	81		2	27
Compressor Ratio	82		2	28
Compressor Sidechain EQ	83		2	29
Compressor Dry/Wet Mix	84		2	30
Compressor Output Volume	85		2	31

C.7 MACHINE PARAMETERS

The following shows the SYNTH parameters per MACHINE type.

BD PLASTIC				
Parameter	CC MSB	CC LSB	NRPN MSB	NRPN LSB
Level	16		1	0
Tune	17		1	1
Decay Time	18		1	2
Sweep Depth	19		1	3
Sweep Time	20		1	4
Hold Time	21		1	5
VCO Click	22		1	6
Dust Level	23		1	7

BD SHARP				
Parameter	CC MSB	CC LSB	NRPN MSB	NRPN LSB
Level	16		1	0
Tune	17		1	1
Decay	18		1	2
Sweep Depth	19		1	3
Sweep Time	20		1	4
Hold Time	21		1	5
Tick Level	22		1	6
Waveform	23		1	7

BD HARD				
Parameter	CC MSB	CC LSB	NRPN MSB	NRPN LSB
Level	16		1	0
Tune	17		1	1
Decay	18		1	2
Hold	19		1	3
Sweep Time	20		1	4
Sweep Depth	21		1	5
Waveform	22		1	6
Transient Tick	23		1	7

BD CLASSIC				
Parameter	CC MSB	CC LSB	NRPN MSB	NRPN LSB
Level	16		1	0
Tune	17		1	1
Decay	18		1	2
Hold	19		1	3
Sweep Time	20		1	4
Sweep Depth	21		1	5
Waveform	22		1	6
Transient Tick	23		1	7

BD FM				
Parameter	CC MSB	CC LSB	NRPN MSB	NRPN LSB
Level	16		1	0
Tune	17		1	1
Decay	18		1	2
FM Amount	19		1	3
Sweep Time	20		1	4
FM Sweep Time	21		1	5
FM Decay Time	22		1	6
FM Tune	23		1	7

BD SILKY				
Parameter	CC MSB	CC LSB	NRPN MSB	NRPN LSB
Level	16		1	0
Tune	17		1	1
Decay	18		1	2
Sweep Depth	19		1	3
Sweep Time	20		1	4
Hold	21		1	5
VCO Click	22		1	6
Dust Level	23		1	7

SD NATURAL				
Parameter	CC MSB	CC LSB	NRPN MSB	NRPN LSB
Level	16		1	0
Tune	17		1	1
Body Decay	18		1	2
Noise Decay	19		1	3
Noise LPF	20		1	4
Noise Balance	21		1	5
Noise Resonance	22		1	6
Noise HPF	23		1	7

SD HARD				
Parameter	CC MSB	CC LSB	NRPN MSB	NRPN LSB
Level	16		1	0
Tune	17		1	1
Decay	18		1	2
Sweep Depth	19		1	3
Tick Level	20		1	4
Noise Decay	21		1	5
Noise Level	22		1	6
Sweep Time	23		1	7

SD CLASSIC				
Parameter	CC MSB	CC LSB	NRPN MSB	NRPN LSB
Level	16		1	0
Tune	17		1	1
Decay	18		1	2
Detune	19		1	3
Snap Amount	20		1	4
Noise Decay	21		1	5
Noise Level	22		1	6
Osc Balance	23		1	7

SD FM				
Parameter	CC MSB	CC LSB	NRPN MSB	NRPN LSB
Level	16		1	0
Tune	17		1	1
Decay	18		1	2
FM Tune	19		1	3
FM Decay Time	20		1	4
Noise Decay	21		1	5
Noise Level	22		1	6
FM Amount	23		1	7

RS HARD				
Parameter	CC MSB	CC LSB	NRPN MSB	NRPN LSB
Level	16		1	0
Tune	17		1	1
Decay	18		1	2
Sweep Depth	19		1	3
Tick Level	20		1	4
Noise Level	21		1	5
Symmetry	22		1	6
Sweep Time	23		1	7

RS CLASSIC				
Parameter	CC MSB	CC LSB	NRPN MSB	NRPN LSB
Level	16		1	0
Tune Osc 1	17		1	1
Decay	18		1	2
Osc Balance	19		1	3
Tune Osc 2	20		1	4
Symmetry	21		1	5
Noise Level	22		1	6
Tick Level	23		1	7

CP CLASSIC				
Parameter	CC MSB	CC LSB	NRPN MSB	NRPN LSB
Level	16		1	0
Noise Tone	17		1	1
Noise Decay	18		1	2
Clap Number	19		1	3
Clap Rate	20		1	4
Noise Level	21		1	5
Random Claps	22		1	6
Clap Decay	23		1	7

DUAL VCO				
Parameter	CC MSB	CC LSB	NRPN MSB	NRPN LSB
Level	16			
Osc 1 Tune	17			
Osc 1 Decay	18			
Balance	19			
Osc 2 Detune	20			
Osc Config	21			
Osc 2 Decay	22			
Bend	23			

BT CLASSIC				
Parameter	CC MSB	CC LSB	NRPN MSB	NRPN LSB
Level	16		1	0
Tune	17		1	1
Decay	18		1	2
Noise Level	20		1	4
Snap Type	21		1	5

LT, MT, HT CLASSIC				
Parameter	CC MSB	CC LSB	NRPN MSB	NRPN LSB
Level	16		1	0
Tune	17		1	1

LT, MT, HT CLASSIC				
Parameter	CC MSB	CC LSB	NRPN MSB	NRPN LSB
Decay	18		1	2
Sweep Depth	19		1	3
Sweep Time	20		1	4
Noise Decay	21		1	5
Noise Level	22		1	6
Noise Tone	23		1	7

CH CLASSIC				
Parameter	CC MSB	CC LSB	NRPN MSB	NRPN LSB
Level	16		1	0
Tune	17		1	1
Decay	18		1	2
Color	19		1	3

CH METALLIC				
Parameter	CC MSB	CC LSB	NRPN MSB	NRPN LSB
Level	16		1	0
Tune	17		1	1
Decay Time	18		1	2

OH CLASSIC				
Parameter	CC MSB	CC LSB	NRPN MSB	NRPN LSB
Level	16		1	0
Tune	17		1	1
Decay	18		1	2
Color	19		1	3

OH METALLIC				
Parameter	CC MSB	CC LSB	NRPN MSB	NRPN LSB
Level	16		1	0
Tune	17		1	1
Decay Time	18		1	2

HH BASIC				
Parameter	CC MSB	CC LSB	NRPN MSB	NRPN LSB
Level	16		1	0
Tune	17		1	1
Decay Time	18		1	2
Tone	19		1	3
Transient Decay	20		1	4
Osc Reset	21		1	5

CY METALLIC

Parameter	CC MSB	CC LSB	NRPN MSB	NRPN LSB
Level	16		1	0
Tune	17		1	1
Decay Time	18		1	2
Tone	19		1	3
Transient Decay	20		1	4

CY CLASSIC

Parameter	CC MSB	CC LSB	NRPN MSB	NRPN LSB
Level	16		1	0
Tune	17		1	1
Decay	18		1	2
Color	19		1	3
Tone	20		1	4

CY RIDE

Parameter	CC MSB	CC LSB	NRPN MSB	NRPN LSB
Level	16		1	0
Tune	17		1	1
Tail Decay	18		1	2
Hit Decay	19		1	3
Cymbal Type	20		1	4
Component 1	21		1	5
Component 2	22		1	6
Component 3	23		1	7

CB CLASSIC & METALLIC

Parameter	CC MSB	CC LSB	NRPN MSB	NRPN LSB
Level	16		1	0
Tune	17		1	1
Decay Time	18		1	2
Detune	19		1	3

NOISE

Parameter	CC MSB	CC LSB	NRPN MSB	NRPN LSB
Level	16		1	0
LP Frequency	17		1	1
Decay	18		1	2
Sweep Depth	19		1	3
Sweep Time	20		1	4
LP Resonance	21		1	5
HP Frequency	22		1	6
Attack	23		1	7

IMPULSE				
Parameter	CC MSB	CC LSB	NRPN MSB	NRPN LSB
Level	16		1	0
Attack	17		1	1
Decay	18		1	2
Polarity	19		1	3

C.8 MIDI NOTE TRIGGERS

Some functions of the Analog Rytm can be triggered by sending MIDI note values from an external MIDI device.

Note that the tracks needs to be set to their default channels 1-12 to be triggered by C0-B0. For more information, please see “8.6 MIDI NOTES” on page 22.

NOTE	FUNCTION
C0(0)	Triggers Sound Track 1
C#0 (1)	Triggers Sound Track 2
D0 (2)	Triggers Sound Track 3
D#0 (3)	Triggers Sound Track 4
E0 (4)	Triggers Sound Track 5
F0 (5)	Triggers Sound Track 6
F#0 (6)	Triggers Sound Track 7
G0 (7)	Triggers Sound Track 8
G#0 (8)	Triggers Sound Track 9
A0 (9)	Triggers Sound Track 10
A#0 (10)	Triggers Sound Track 11
B0 (11)	Triggers Sound Track 12
C1 (12) – B4 (59)	Triggers the active track chromatically

APPENDIX D: MACHINES

This appendix lists the parameters on the SYNTH page of the drum tracks. The parameters available are determined by the MACHINE that has been selected. There are several MACHINES to choose from. See “ANALOG RYTM CONTROLS” on page 14 (illustration) for drum track voice allocation.

The MACHINES below can be used on all tracks: BD, SD, RS, CP, BT, LT, MT, HT, CH, OH, CY and CB.

D.1 ALL

NONE (SYNTH DISABLED)



There are no parameters on the SYNTH page when it is disabled. Select DISABLE, then save, to be able to make a sample-based Sound accessible, for loading and Sound Locking, on any of the 12 Tracks.

NOIS (WHITE NOISE GENERATOR)

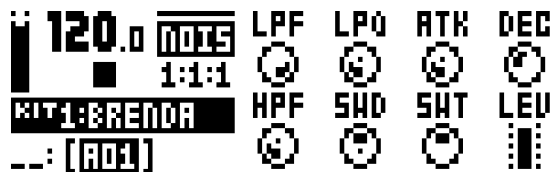

LRF (LP Filter) sets the lowpass filter cutoff frequency. (0-127)

LPQ (LP Resonance) sets the amount of resonance around the cutoff frequency of the LP Filter. Zero value quenches resonance altogether (0-127)

ATK (Attack) sets the length of the attack phase. (0-127)

DEC (Decay) sets the length of the decay phase. (0-INF)

HPF (HP Filter) sets the highpass filter cutoff frequency. (0-127)

SWD (Sweep Depth) sets the depth of the LP Filter sweep. Negative as well as positive sweeps are possible. (-64+63)

SWT (Sweep Time) sets the length of the sweep from the depth set by SWD. Low values result in snappy sweeps, high values result in longer sweeps. (0-127)

LEV (Level) sets the volume of noise. (0-127)

PULS (POSITIVE/NEGATIVE POLARITY IMPULSE)

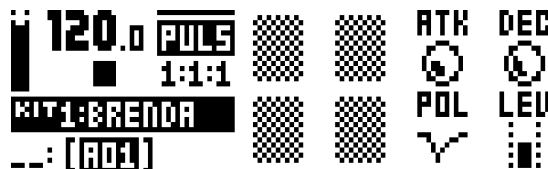

ATK (Attack) sets the length of the attack phase. (0-127)

DEC (Decay) sets the length of the decay phase. (0-127)

POL (Polarity) sets the polarity, positive or negative. (POS, NEG)

LEV (Level) sets the volume of the impulse. (0-127)

The MACHINES below can be used on the BD, SD, RS and CP tracks.

D.2 BASS DRUM

BDHD (BASS DRUM HARD)



TUN (Tune) sets the pitch of the oscillator. (-64-63)

SWT (Sweep Time) sets the pitch sweep time. The depth of the sweep is fixed. (0-127)

SNP (Snap Amount) sets the snap transient level. (0-127)

DEC (Decay) sets the length of the decay phase. (0-127)

WAV (Waveform) sets the oscillator waveform to sine, asymmetric sine or triangle. (0, 1, 2)

HLD (Hold Time) sets the hold time, the time before the decay phase starts. (0-127)

TIC (Tick Level) sets the level of the transient tick. (0-127)

LEV (Level) sets the synth volume. (0-127)

BDCL (BASS DRUM CLASSIC)



TUN (Tune) sets the pitch of the oscillator. (-64+63)

SWT (Sweep Time) sets the pitch sweep time. Low values result in a short sweep. (0-127)

SWD (Sweep Depth) sets the depth of the pitch sweep. (0-127)

DEC (Decay) sets the length of the decay phase. (0-127)

WAV (Waveform) sets the oscillator waveform to sine, asymmetric sine or triangle. (0-127)

HLD (Hold Time) sets the hold time, the time before the decay phase starts. (0-127)

TRA (Transient) sets the tick or noise transient sound and its level. (0-127)

LEV (Level) sets the synth volume. (0-127)

BDFM (BASS DRUM FM)



TUN (Tune) sets the pitch of the first (modulated) oscillator. (-64+63)

SWT (Sweep Time) sets the pitch sweep time of the first (modulated) oscillator. (0-127)

FMD (FM Decay) sets the length of the decay phase of the second (modulating) oscillator and, consequently, the decay time of the FM effect. (0-127)

DEC (Decay) sets the length of the decay phase of the first (modulated) oscillator and, consequently, the whole drum sound. (0-127)

FMT (FM Tune) sets the pitch of the second (modulating) oscillator. (0-127)

FMS (FM Sweep Time) sets the pitch sweep time of the second (modulating) oscillator. (0-127)

FMA (FM Amount) sets the amount of frequency modulation the second oscillator subjects the first to. Range (0-127).

LEV (Level) sets the synth volume. (0-127)

BDPL (BASS DRUM PLASTIC)

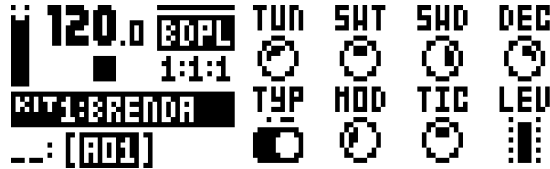

TUN (Tune) sets the pitch of the two interacting oscillators. (-64--+63)

SWT (Sweep Time) sets the pitch sweep time of the two interacting oscillators. (0-127)

SWD (Sweep Depth) sets the depth of the pitch sweep. (0-127)

DEC (Decay) sets the length of the decay phase. (0-127)

TYP (Modulation Type) The first (A) is linear Frequency Modulation between the oscillators. The second (B) is FM combined with ring modulation.

MOD (Modulation Level) sets modulation depth. Both types of modulation (A, B) produce distinctive harmonics and the plastic buoyancy for which this drum model is so aptly named. (0-127)

TIC (Tick Level) sets the level of the transient tick. (0-127)

LEV (Level) sets the synth volume. (0-127)

BDSH (BASS DRUM SHARP)



TUN (Tune) sets the pitch of the oscillator. (-64--+63)

SWT (Sweep Time) sets the pitch sweep time. (0-127)

SWD (Sweep Depth) sets the depth of the pitch sweep. (0-127)

DEC (Decay) sets the length of the decay phase. (0-127)

HLD (Hold Time) sets the length of the hold phase. (0-127)

TIC (Tick Level) sets the level of transient tick. (0-127)

WAV (Waveform) sets the waveform. There are five waveforms to choose from (Sine, Asymmetric Sine, Triangle, Sinetooth and Sawtooth), and there is a choice between letting the oscillator run freely, or have it reset each time the synth is triggered (wave graphics showed with an anchor point on the LCD).

LEV (Level) sets the synth volume. (0-127)

BDSI (BASS DRUM SILKY)



TUN (Tune) sets the pitch of the oscillator. (-64--+63)

SWT (Sweep Time) sets the pitch sweep time. (0-127)

SWD (Sweep Depth) sets the depth of the pitch sweep. (0-127)

DEC (Decay) sets the length of the decay phase. (0-127)

- HLD (Hold Time) sets the length of the hold phase. (0-127)
- DUS (Dust Level) sets the level of subtle tape-like static. (0-127)
- CLK (VCO Click) sets the soft, oscillator-generated click level. (0-127)
- LEV (Level) sets the synth volume. (0-127)

D.3 SNARE DRUM

SDHD (SNARE DRUM HARD)

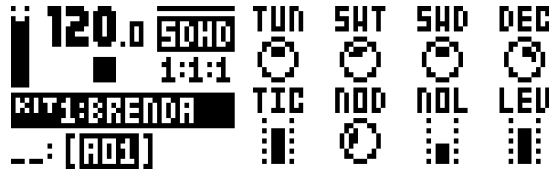

- TUN (Tune) sets the pitch of the oscillators. The interval between them is fixed. (-64+63)
- SWT (Sweep Time) sets the pitch sweep time. (0-127)
- SWD (Sweep Depth) sets the depth of the pitch sweep. (0-127)
- DEC (Decay) sets the length of the decay phase. (0-127)
- TIC (Tick Level) sets the level of the transient tick. (0-127)
- NOD (Noise Decay) sets the length of the noise decay phase. (0-127)
- NOL (Noise Level) sets the noise level. (0-127)
- LEV (Level) sets the synth volume. (0-127)

SDCL (SNARE DRUM CLASSIC)

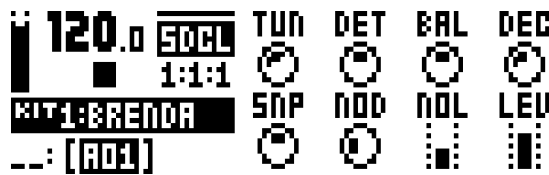

- TUN (Tune) sets the common pitch of the oscillators. (-64+63)
- DET (Detune) sets the pitch of the second oscillator in relation to the first. (-64+63)
- BAL (Osc Balance) sets the balance between the levels of oscillator 1 and oscillator 2. (-64+63)
- DEC (Decay) sets the length of the decay phase. (0-127)
- SNP (Snap Amount) sets the snap transient level. (0-127)
- NOD (Noise Decay) sets the length of the noise decay phase. (0-127)
- NOL (Noise Level) sets the noise level. (0-127)
- LEV (Level) sets the synth volume. (0-127)

SDFM (SNARE DRUM FM)



- TUN (Tune) sets the pitch of the first (modulated) oscillator. (-64+63)
- FMT (FM Tune) sets the pitch of the second (modulating) oscillator. (-64-63)
- FMD (FM Decay Time) sets the decay time of the second (modulating) oscillator and, consequently, the decay time of the FM effect. (0-127)

DEC (Decay) sets the length of the decay phase of the first (modulated) oscillator and, consequently, the whole drum sound. (0–127)

FMA (FM Amount) sets the amount of frequency modulation the second oscillator subjects the first to. (0–127)

NOD (Noise Decay) sets the length of the noise decay phase. (0–127)

NOL (Noise Level) sets the noise level. (0–127)

LEV (Level) sets the synth volume. (0–127)

SDNA (SNARE DRUM NATURAL)



TUN (Tune) sets the pitch of the first oscillator. (-64–+63)

DEC (Noise Decay) sets the length of the noise decay. (0–127)

BAL (Noise Balance) sets the balance between noise and oscillator. (0–127)

BDY (Decay Time) sets the length of the decay phase of the oscillator. (0–127)

HPF (Noise HPF) sets the noise highpass filter cutoff frequency. (0–127)

LPF (Noise LPF) sets the noise lowpass filter cutoff frequency. (0–127)

RES (Noise Resonance) adds a resonant peak to the Noise LPF. Zero value quenches noise resonance altogether. (0–127)

LEV (Level) sets the synth volume. (0–127)

The MACHINES below can only be used on the RS and CP tracks.

D.4 RIMSHOT

RSHD (RIMSHOT HARD)



TUN (Tune) sets the pitch of the oscillators. (-64–+63)

SWT (Sweep Time) sets the pitch sweep time. (0–127)

SWD (Sweep Depth) sets the depth of the pitch sweep. (0–127)

DEC (Decay) sets the length of the decay phase. (0–127)

SYM (Symmetry) adjusts the nonlinearity in the special rimshot circuit. (0–127)

TIC (Tick Level) sets the level of the transient tick. (0–127)

NOL (Noise Level) sets the noise level. (0–127)

LEV (Level) sets the synth volume. (0–127)

RSCL (RIMSHOT CLASSIC)



- T1 (Tune Osc1) sets the pitch of the first oscillator. (-64+63)
- T2 (Tune Osc2) sets the pitch of the second oscillator. (-64+63)
- BAL (Osc Balance) sets the balance between oscillator 1 and oscillator 2. (-64+63)
- DEC (Decay) sets the length of the decay phase. (0-127)
- SYM (Symmetry) adjusts the nonlinearity in the special rimshot circuit. (-64+63)
- TIC (Tick Level) sets the level of the transient tick. (0-127)
- NOL (Noise Level) sets the noise level. (0-127)
- LEV (Level) sets the synth volume. (0-127)

D.5 HAND CLAP

CPCL (HAND CLAP CLASSIC)

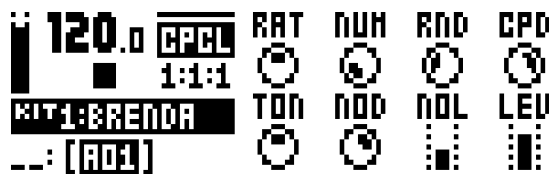

- RAT (Clap Rate) sets the rate of the hand claps. (0-127)
- NUM (Clap Number) sets the number of hand claps. (0-127)
- RND (Random Claps) randomizes the timing of the hand claps. (0-127)
- CPD (Clap Decay) sets the length of the decay phase. (0-127)
- TON (Noise Tone) sets the pitch of the noise. (0-127)
- NOD (Noise Decay) sets the length of the decay phase of the noise. (0-127)
- NOL (Noise Level) sets the noise level. (0-127)
- LEV (Level) sets the synth volume. (0-127)

D.6 DUAL VCO

DUAL (DUAL VCO)



- TUN (Osc 1 Tune) sets the tuning of oscillator 1. Value 0 corresponds to note C-2. One octave corresponds to 24 units. (-64+63)
- DET (Osc 2 Detune) sets the tuning of oscillator 2, relative to oscillator 1. One octave corresponds to 48 units. (-64+63)
- DEC (Osc 1 Decay) sets the decay time of oscillator 1 level. (0-127)
- DEC (Osc 2 Decay) sets the decay time of oscillator 2 level. (0-127)
- CFG (Osc Config) selects the waveforms and interaction of the two oscillators. There are two different waveforms for oscillator 1 (sine, sinesaw) and five different waveforms for oscillator 2 (sine, skewed sine, triangle, sinesaw, saw).
 - “+” = Mixes the oscillators.
 - “R” = Ring modulation.
 - “F” = Frequency modulation (linear) with osc 1 as the carrier. (Does not pitch track 100% correct)
 - “FR” = Frequency modulation (linear) and Ring modulation (Does not pitch track 100% correct)
 - “_” = Resets the oscillators on trig.
- BND (Bend) sets the depth of a fixed time pitch envelope. One octave corresponds to 24 units (-64+63)

BAL (Balance) controls the levels of the two oscillators. At a value of 0, both are max. Negative values attenuate oscillator 2. Positive values attenuate oscillator 1. (-64--+63)

LEV (Level) sets the overall sound volume of the machine. (0-127)

The MACHINE below can be used on the BT track.

D.7 BASS TOM

BTCL (BASS TOM CLASSIC)

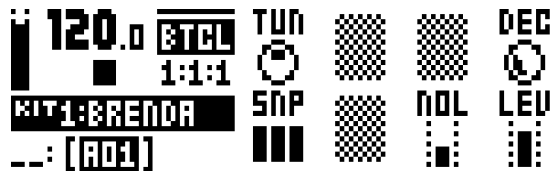

TUN (Tune) sets the pitch of the oscillator. (-64--+63)

DEC (Decay) sets the length of the decay phase. (0-127)

SNP (Snap) sets the length of the snap transient. (0, 1, 2, 3)

NOL (Noise Level) sets the noise level. (0-127)

LEV (Level) sets the synth volume. (0-127)

The MACHINE below can be used on the LT, MT, and HT tracks.

D.8 LOW, MID, HIGH TOM

XTCL (TOM CLASSIC)

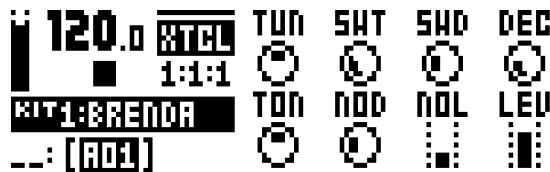

TUN (Tune) sets the pitch of the oscillator. (-64--+63)

SWT (Sweep Time) sets the pitch sweep time. (0-127)

SWD (Sweep Depth) sets the depth of the pitch sweep. (0-127)

DEC (Decay) sets the length of the decay phase. (0-127)

TON (Noise Tone) sets the pitch of the noise. (-64--+63)

NOD (Noise Decay) sets the length of the noise decay phase. (0-127)

NOL (Noise Level) sets the noise level. (0-127)

LEV (Level) sets the synth volume. (0-127)

The MACHINES below can be used on the CH and OH tracks.

D.9 CLOSED HIHAT

HHBA (HIHAT BASIC)

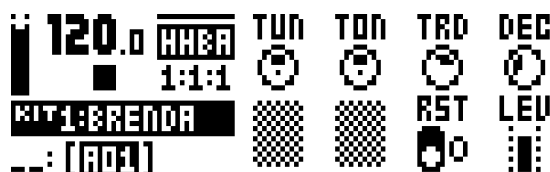

TUN (Tune) sets the pitch of the six oscillators that combine to make the basic hihat sound. (-64--+63)

TON (Tone) sets the tone of the sound. Positive values produce an increasingly shrill tone, while negative values result in a deeper tone. (-64--+63)

TRD (Transient Decay) sets the length of the transient. (0-127)

DEC (Decay) sets the length of the hihat sound. (0-127)

RST (Osc Reset) activate to reset the oscillators for each triggering of the sound, or deactivate to let the oscillators run free. (0, 1)

LEV (Level) sets the synth volume. (0-127)

CHCL (CLOSED HIHAT CLASSIC)

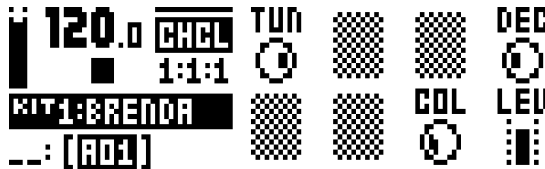

TUN (Tune) sets the pitch of the oscillators of the closed hihat. (-64--+63)

DEC (Decay) sets the length of the decay phase of the closed hihat sound. (0-127)

COL (Noise Color) sets the timbral color, the virtual hardness of the imaginary metal alloy of which the immaterial hihat is made. (-64--+63)

LEV (Level) sets the synth volume. (0-127)

CHMT (CLOSED HIHAT METALLIC)

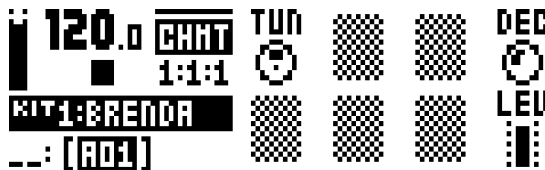

TUN (Tune) sets the pitch of the interacting oscillators of the metallic hihat. (-64--+63)

DEC (Decay) sets the length of the decay phase. (0-127)

LEV (Level) sets the synth volume. (0-127)

D.10 OPEN HIHAT

OHCL (OPEN HIHAT CLASSIC)

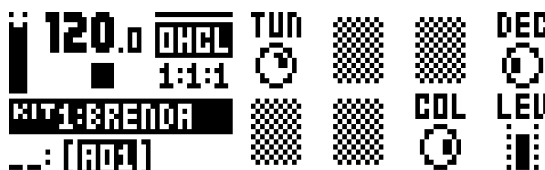

TUN (Tune) sets the pitch of the oscillators of the open hihat. (-64--+63)

DEC (Decay) sets the length of the decay phase. (0-127)

COL (Noise Color) sets the timbral color. (-64--+63)

LEV (Level) sets the synth volume. (0-127)

OHMT (OPEN HIHAT METALLIC)

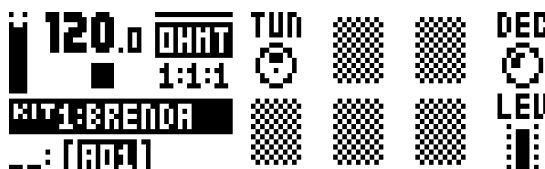

TUN (Tune) sets the pitch of the oscillators of the metallic hihat. (-64--+63)

DEC (Decay) sets the length of the decay phase. (0-127)

LEV (Level) sets the synth volume. (0-127)

The **MACHINES** below can be used on the **CY** and **CB** tracks.

D.11 CYMBAL

CYCL (CYMBAL CLASSIC)



TUN (Tune) sets the pitch of the interacting oscillators of the cymbal. (-64--+63)

TON (Tone) sets the metallic tone of the cymbal. (-64--+63)

DEC (Decay) sets the length of the decay phase of the cymbal sound. (0-127)

COL (Noise Color) sets the timbral color of the cymbal. (-64--+63)

LEV (Level) sets the synth volume. (0-127)

CYMT (CYMBAL METALLIC)



TUN (Tune) sets the pitch of the ring-modulated oscillators of the metallic cymbal. (-64--+63)

TON (Tone) sets the tone of the metallic transient. (-64--+63)

TRD (Transient Decay) sets the length of the transient decay phase. (0-127)

DEC (Decay) sets the length of the decay phase of the oscillators. (0-127)

LEV (Level) sets the synth volume. (0-127)

CYRD (CYMBAL RIDE)



TUN (Tune) sets the pitch of the interacting oscillators that make up the ride cymbal model. (-64--+63)

TYP (Cymbal Type) selects different sets of fundamental oscillator frequencies, as well as different inter-oscillator logical interaction. (A-D)

HIT (Hit Decay) sets the top decay. (0-127)

DEC (Tail Decay) sets the tail decay. (0-127)

C1, C2, C3 (Component 1, 2, 3) sets the level of each component. (0-127)

LEV (Level) sets the synth volume. (0-127)

D.12 COWBELL

CBCL (COWBELL CLASSIC)



TUN (Tune) sets the base pitch of the two oscillators. (-64→+63)

DEC (Decay) sets the length of the decay phase of the cowbell sound. (0-127)

DET (Detune) sets the detune offset of the second oscillator. (0-127)

LEV (Level) sets the synth volume. (0-127)

CBMT (COWBELL METALLIC)



TUN (Tune) sets the base pitch of the two oscillators. (-64→+63)

DEC (Decay) sets the length of the decay phase of the metallic cowbell sound. (0-127)

DET (Detune) sets the detune offset of the second oscillator. (0-127)

LEV (Level) sets the synth volume. (0-127)

INDEX

+DRIVE 14**A****ACCENT 47****AMP 73****B****BACKUP 18****C****CHAINS 50****CHROMATIC MODE 23****COMPRESSOR 76****CONDITIONAL LOCKS 45****CONNECTORS 12****COPY, PASTE AND CLEAR 48****D****DATA STRUCTURE 14**

Kits 14

Project 14

Sounds 14

DELAY 75**DISTORTION 76****DRUM TRACK PARAMETERS 72**

Amp 73

Filter 73

LFO 74

Sample 72

Synth 72

F**FACTORY RESET 62****FILL MODE 45****FILTER 73****FX TRACK PARAMETERS 75**

Compressor 76

Delay 75

Distortion 76

FX LFO 77

Reverb 75

G**GLOBAL 53**

MIDI config 55

Sequencer config 59

GRID RECORDING MODE 39**K****KEY COMBINATIONS 67****KITS AND SOUNDS 27**

Clear kit 28

Editing a sound 34

Kit menu 27

Load kit 27

Playing a sound 34

Save kit 28

Selecting a sample 35

Sound menu 31

L**LFO 74****M****MACHINES 22**

Parameters 89

MIDI 55

MIDI config 55

Port config 56

MIDI CC & NRPN 79**MUTE MODE 23****N****NAMING SCREEN 17****O****OS UPGRADE 60****OVERBRIDGE 17****P****PANEL LAYOUT 10****PARAMETER LOCKS 45****PATTERN MODES 38**

Direct jump 38

Direct start 38

Sequential 38

PATTERNS

Grid recording mode 39

Live recording mode 39

Parameter locks 45

Pattern mode 38

Selecting a pattern 37

Tempo 38

Trig Types 38

PERFORMANCE MODE 29**PROJECTS 25**

Load project 25

Project manager 26

Project menu 25

Save project 26

PURGE (REMOVE UNUSED)

Samples 54

Sounds 32

Q**QUANTIZATION 43**

QUICK SAVE AND RELOAD 48

QUICK SCROLLING 17

QUICK START 19

R

RANDOMIZE PARAMETERS 72

RECORDING MODES

Grid recording mode 39

Live recording mode 39

Step recording mode 39

REVERB 75

S

SAFETY AND MAINTENANCE 3

SAMPLE

Loading, unloading, replacing 53

SAMPLES 53

Create a new destination directory 55

Receiving from computer 54

Removing unused 54

SCALE SETUP

Advanced mode 44

Normal mode 44

SCENE MODE 28

SEQUENCER 37

Accent 47

Click track 43

Conditional locks 45

Editing a pattern 38

Parameter locks 45

Pattern control 37

Pattern menu 42

Pattern modes 38

Retrig menu 40

Scale menu 43

Selecting a pattern 37

Sound locks 45

Swing 47

Track menu 41

Trig menu 42

Trig mute 46

SEQUENCER RECORDING MODES

Step recording mode 39

SETUP EXAMPLES 18, 64

Analog Rytm with a monophonic bass machine 64

Analog Rytm with other Elektron gear 64

Analog Rytm with stereophonic drum machine 65

SONGS 50

SOUND ARCHITECTURE 13

SOUND BROWSER 31

SOUND LOCKS 45

SOUND MANAGER 32

SOUNDS

Clear sound 33

Editing a Sound 34

Playing a Sound 34

Purging 32

Rename Sound 33

SPECIFICATIONS 69

STARTUP MENU 62

SWING 47

SYSEX 57

Sysex receive 58

Sysex send 58

T

TECHNICAL INFORMATION 69

TEMPO

Tap tempo 38

Tempo nudge 38

TRIG MENU 42

TRIG MUTE 46

TRIGS

Note 38

Parameter lock 45

Sound lock 45

Trigless lock 38

Trig mute 46

V

VOICE CIRCUITS 13

 elektron